

Elevation One

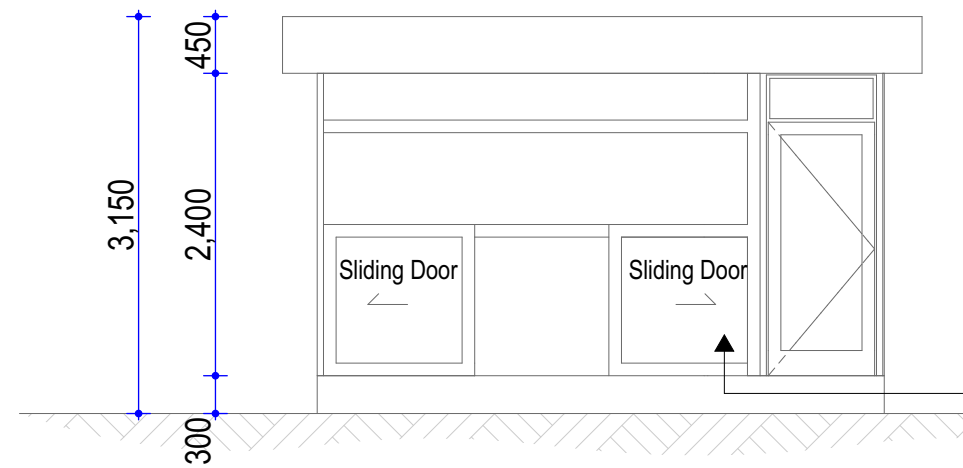

Elevation Two

4mm thick steel plate welded on steel frames and spray painted to approval

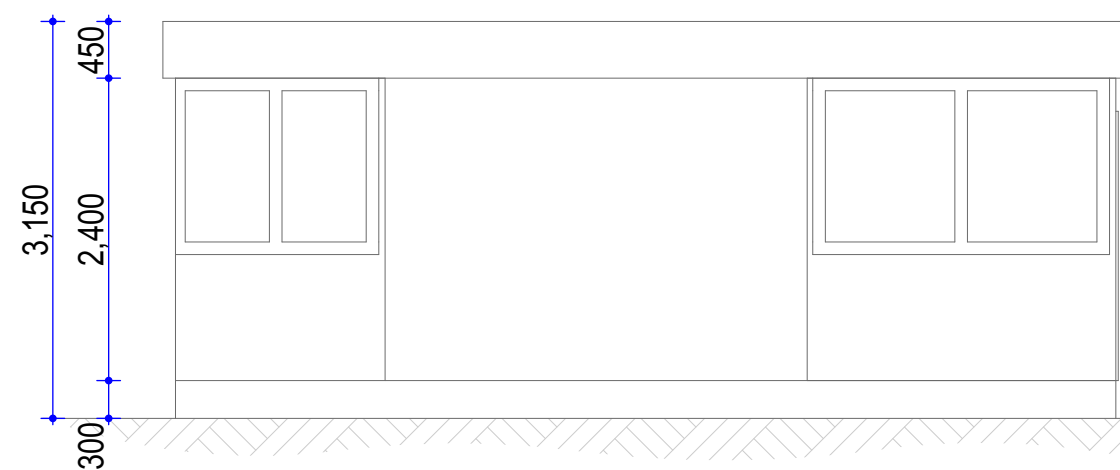

Elevation Three

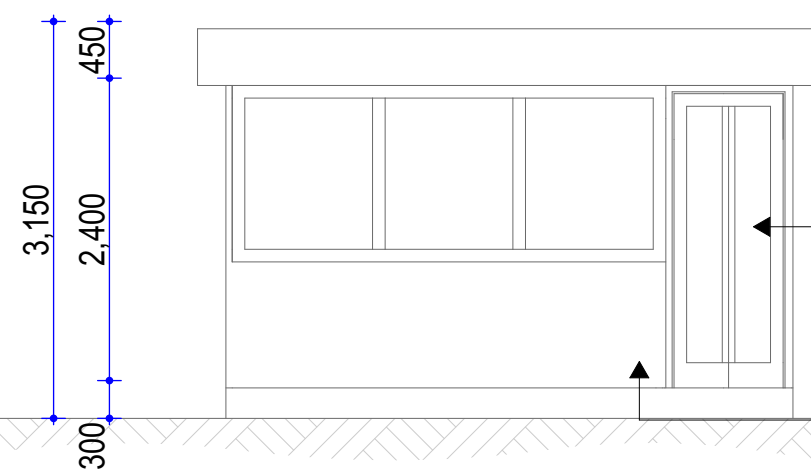

Elevation Four

8mm thick fixed glass
4mm thick steel plate welded on steel frames and spray painted to approval

project: Times Tower {Three Typical Layout}	drawing description	Revision:	Scale: As Shown	
	Drawing No.	Date:	Date:	

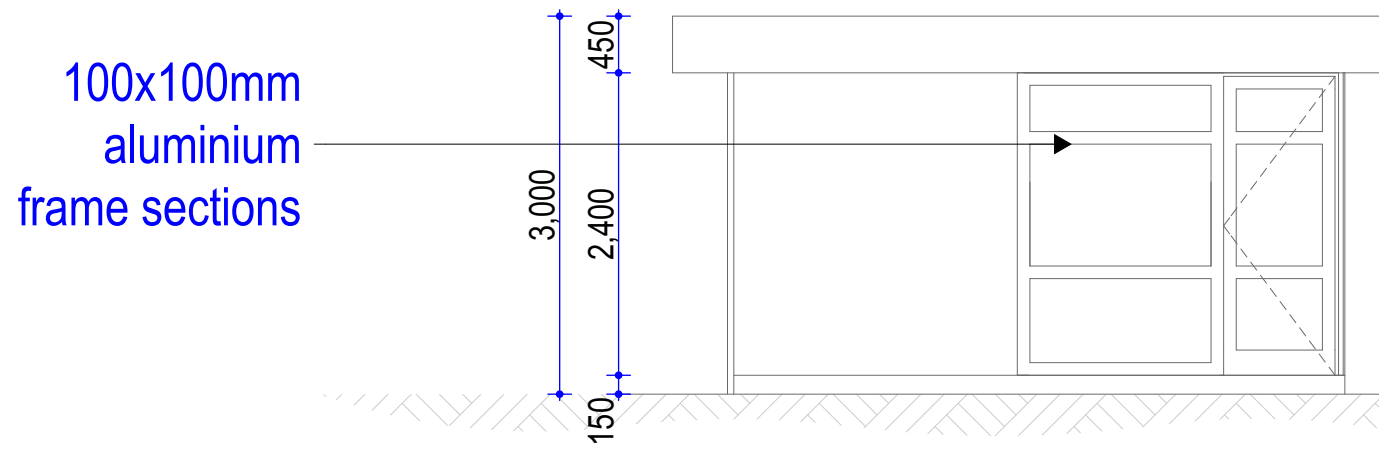
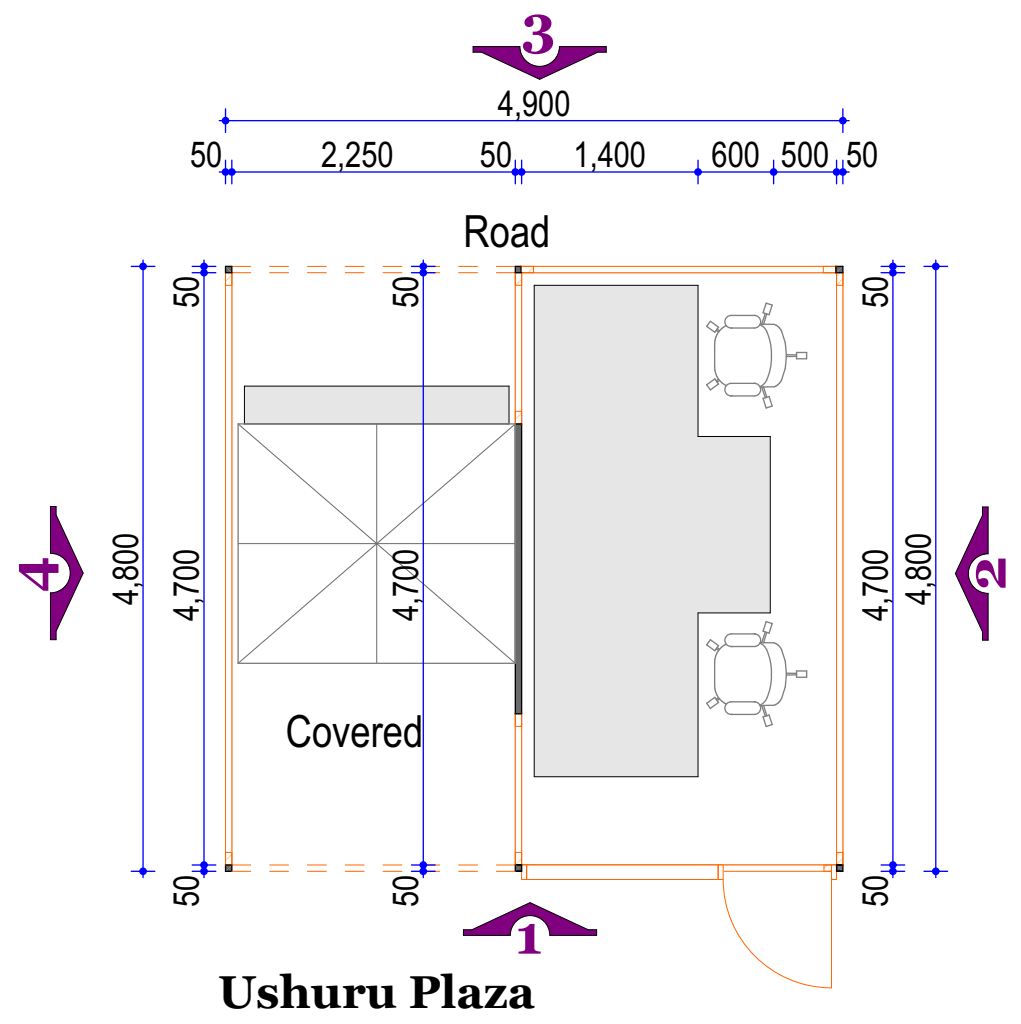

Elevation One

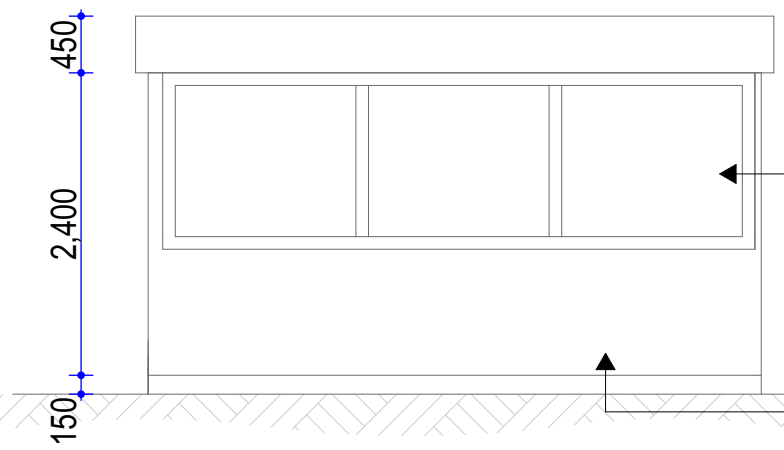

Elevation Two

8mm thick fixed glass
4mm thick steel plate welded on steel frames and spray painted to approval

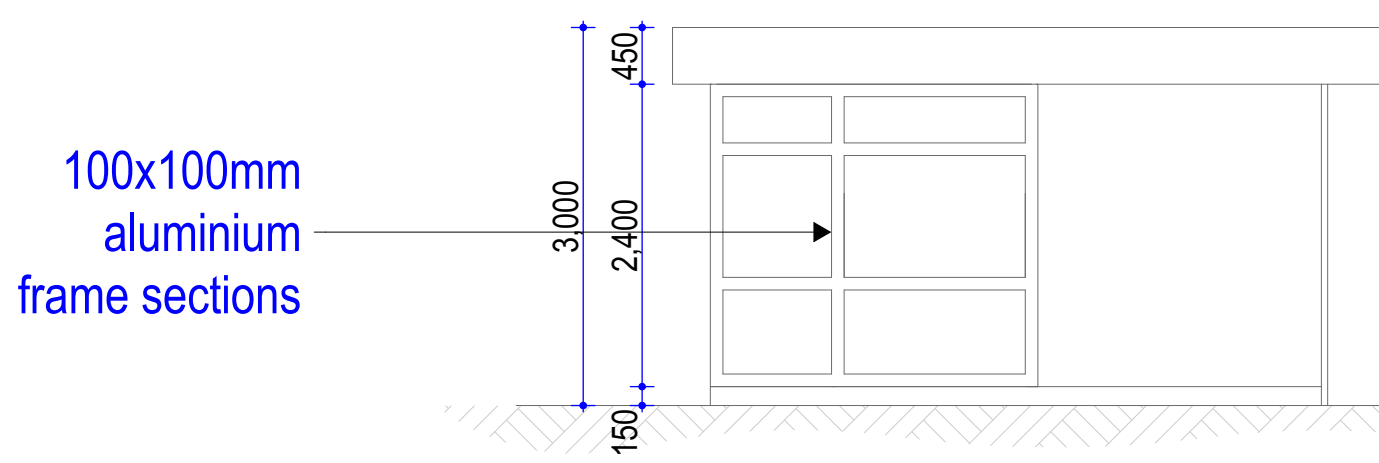

Elevation Three

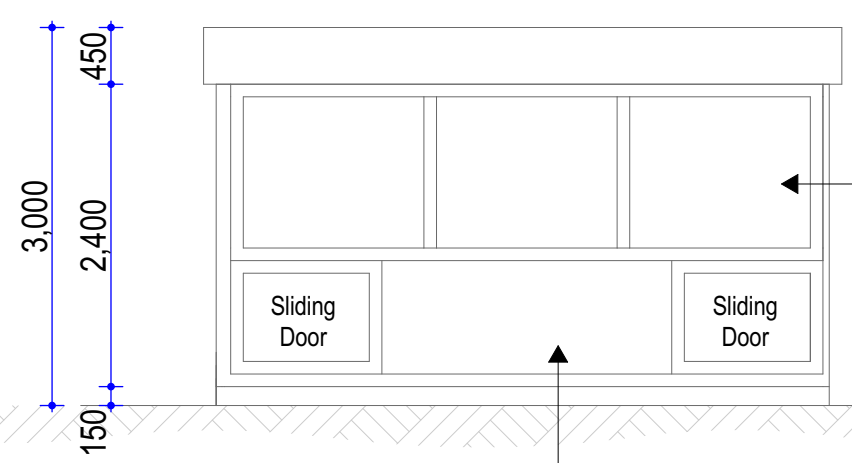

Elevation Four

8mm thick fixed glass
4mm thick steel plate welded on steel frames and spray painted

project: Ushuru Plaza {Two Typical Sheds}	drawing description	Revision:	Scale: As Shown	
	Drawing No.	Date:	Date:	

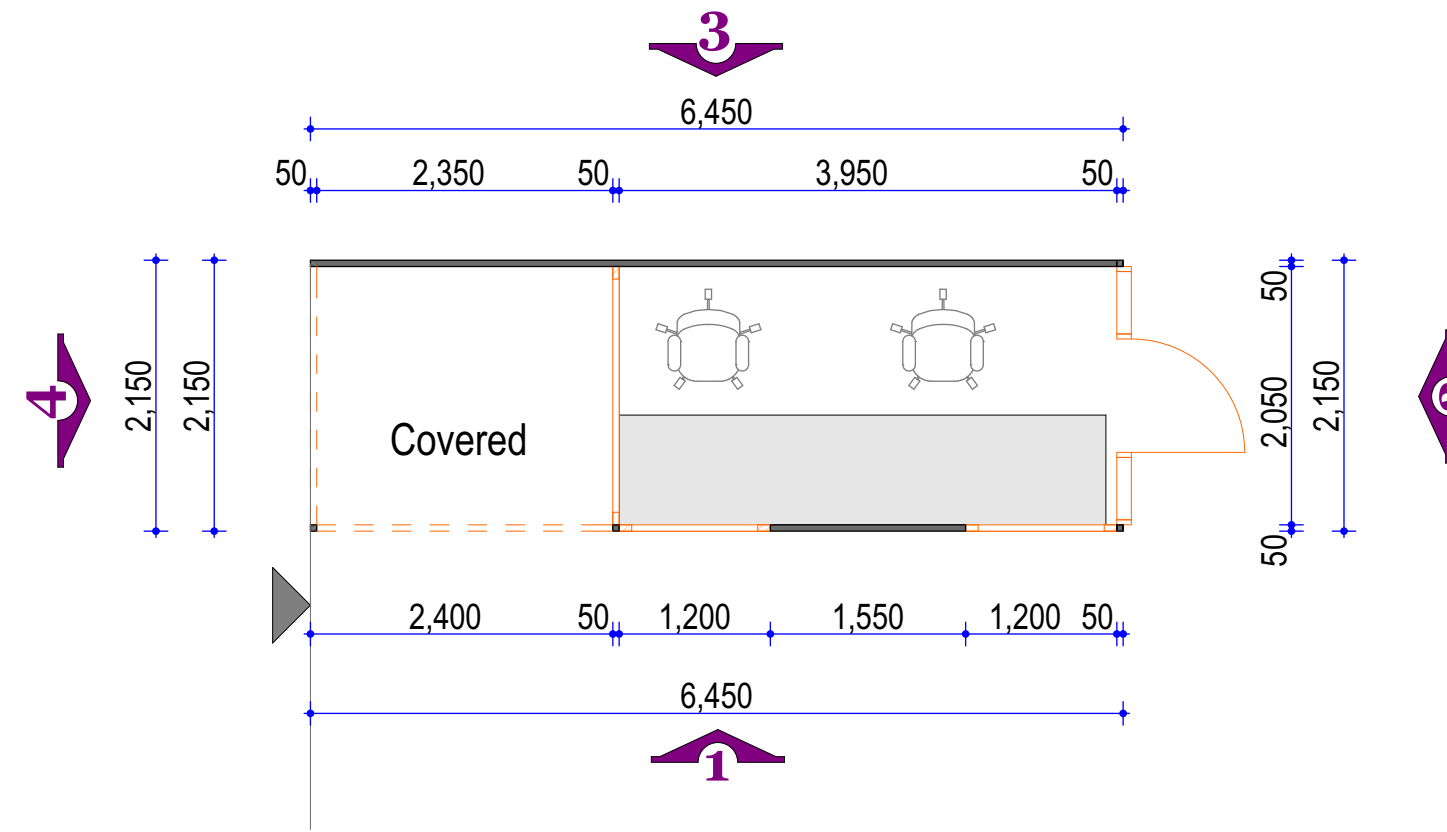

KRA Thika House

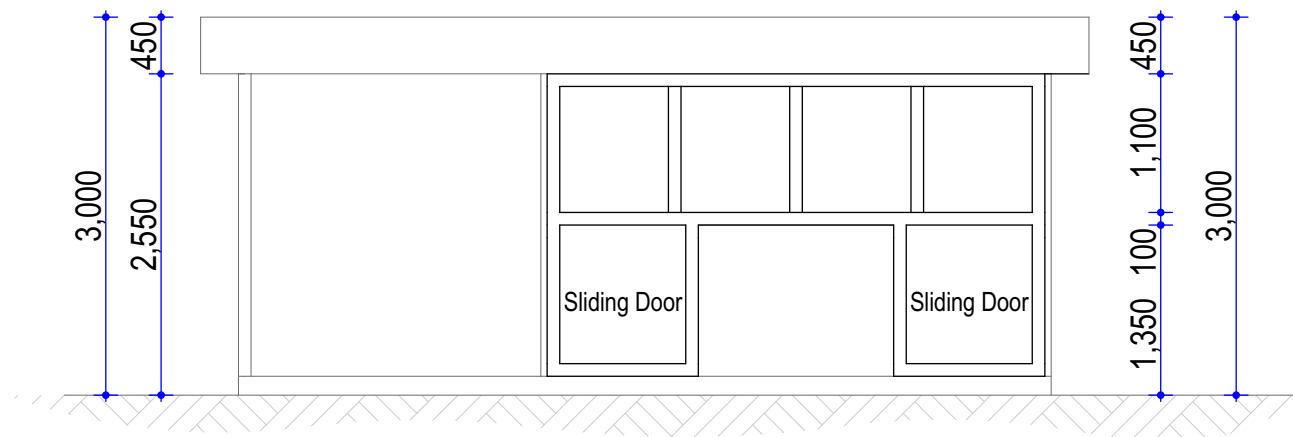

Elevation One

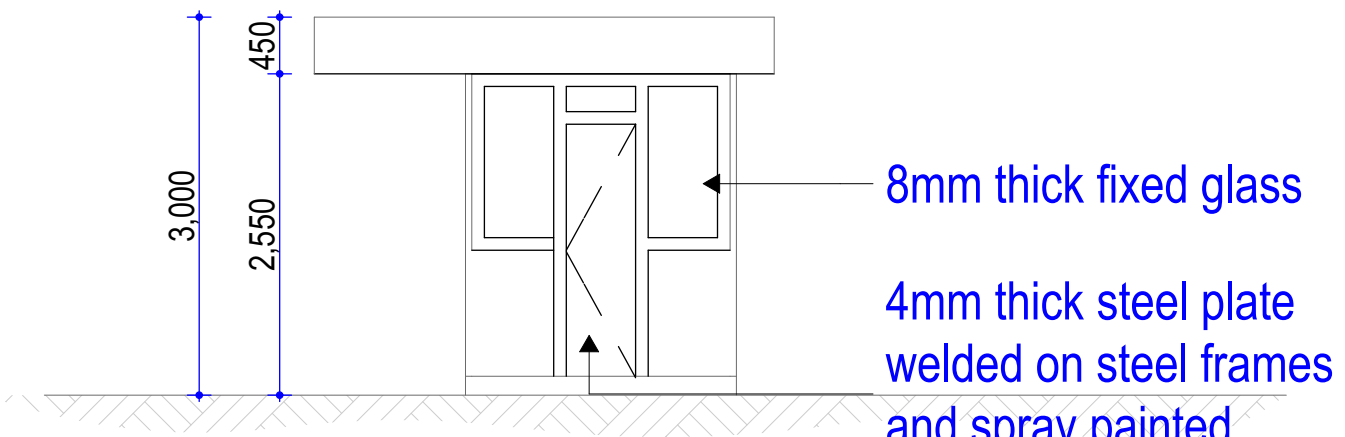

Elevation Two



Elevation Three

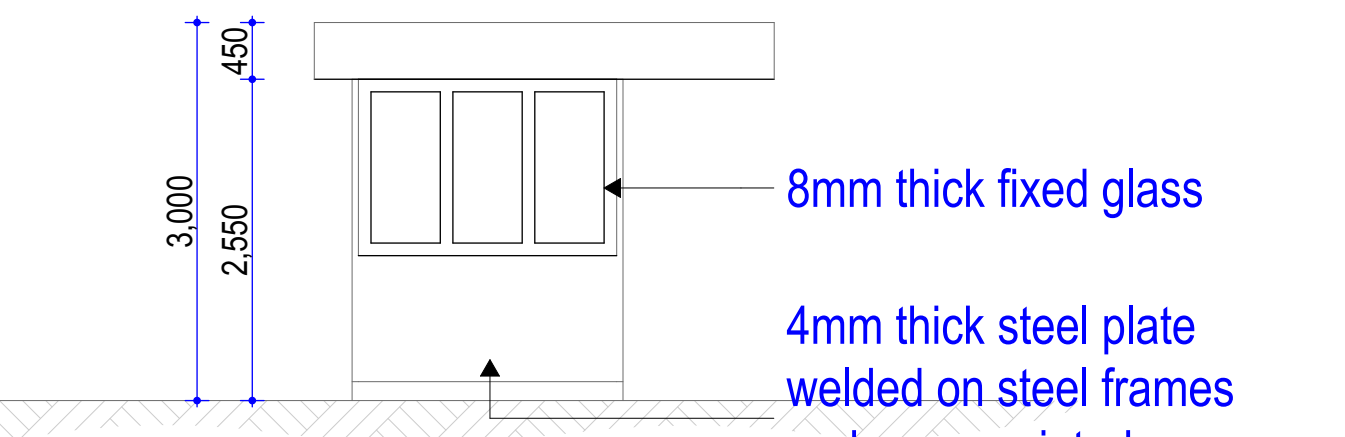

Elevation Four

project: KRA Thika House	drawing description	Revision:	Scale: As Shown	
	Drawing No.	Date:	Date:	

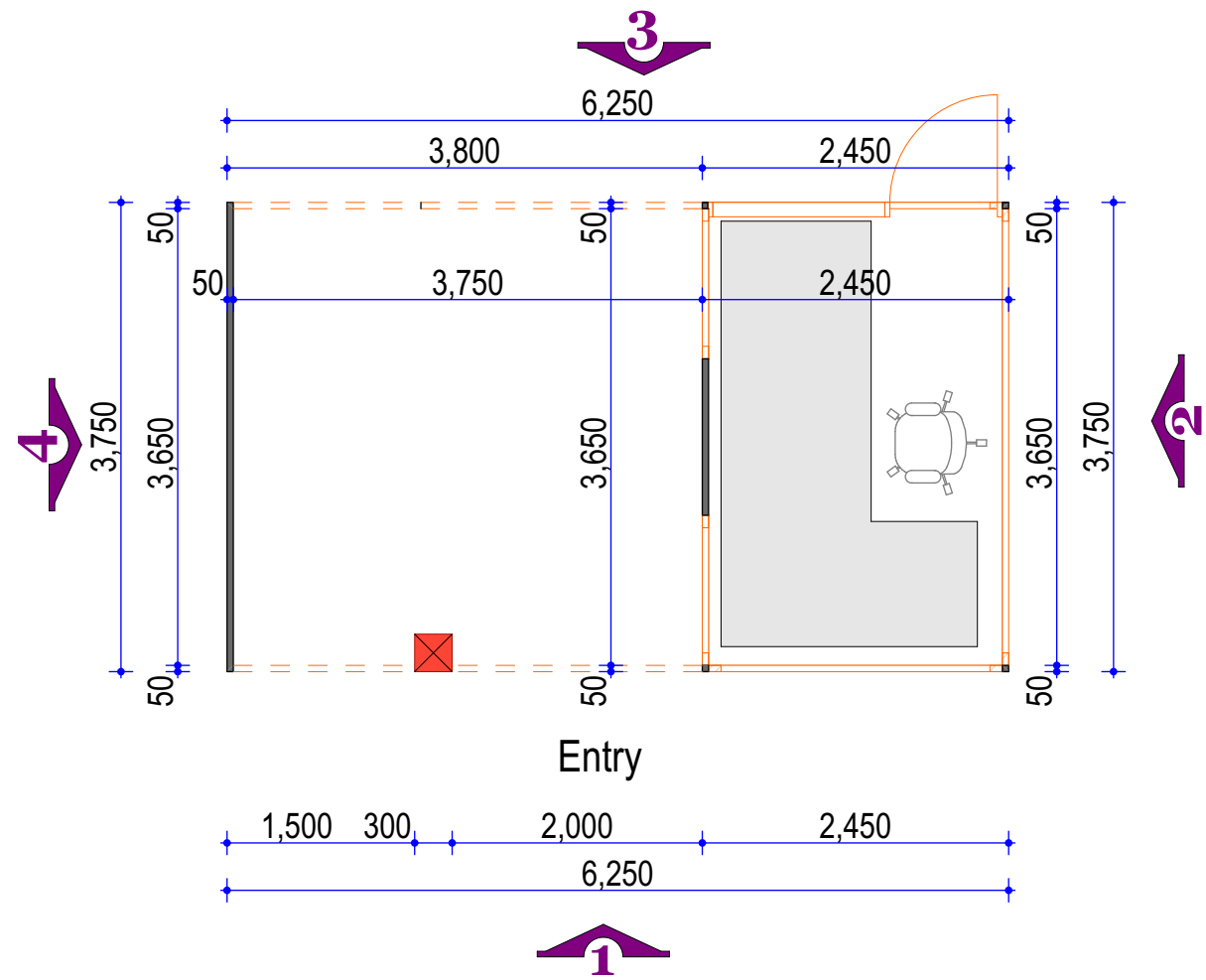

KESRA Basement Parking

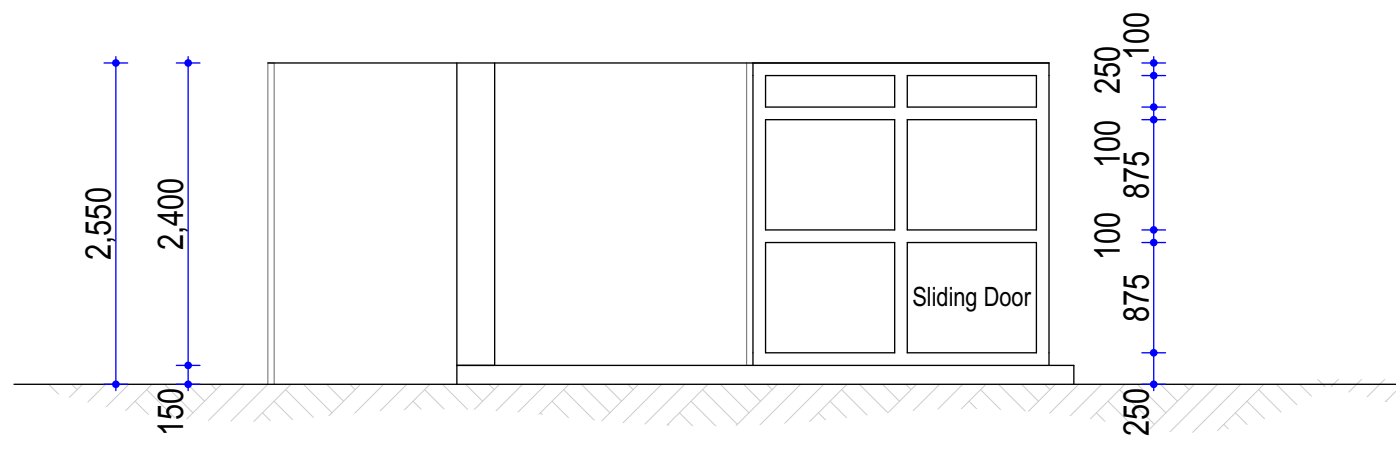

Elevation One

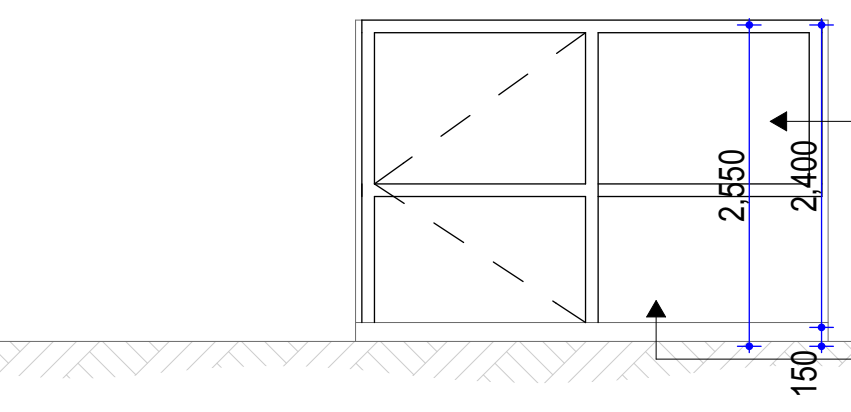

Elevation Two

8mm thick fixed glass
4mm thick steel plate welded on steel frames and spray painted to approval

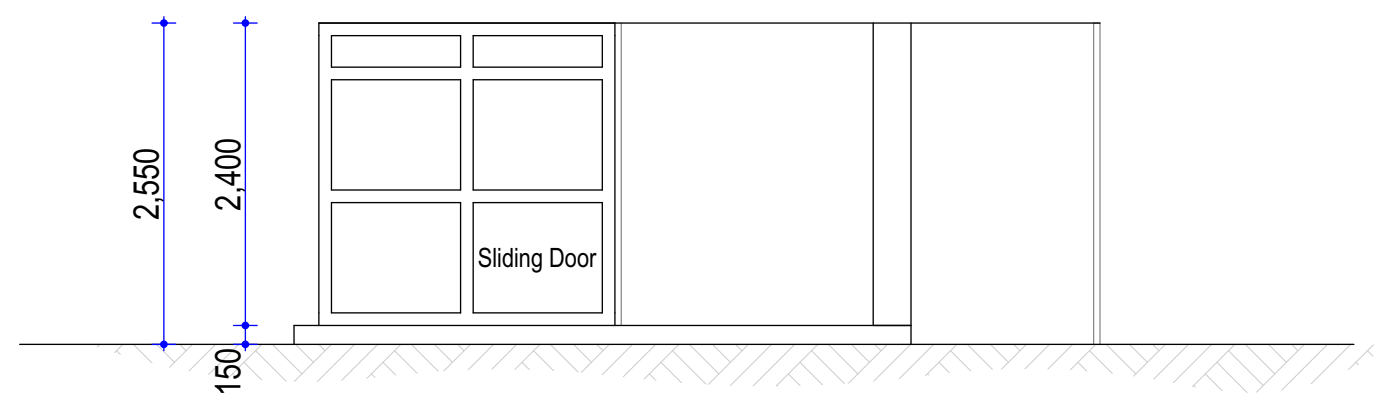

Elevation Three

project: Kesra Basement	drawing description	Revision:	Scale: As Shown	
	Drawing No.	Date:	Date:	

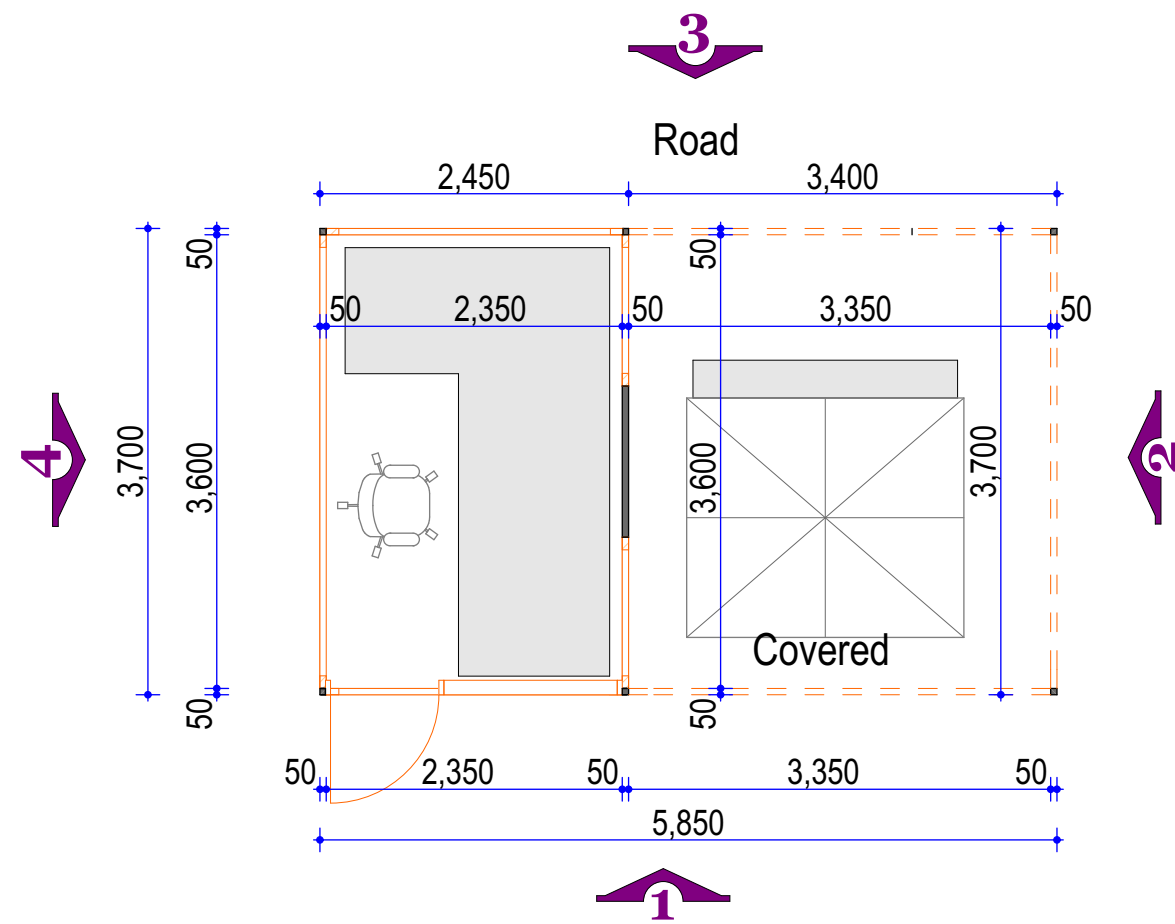

KESRA Pedestrian Entry

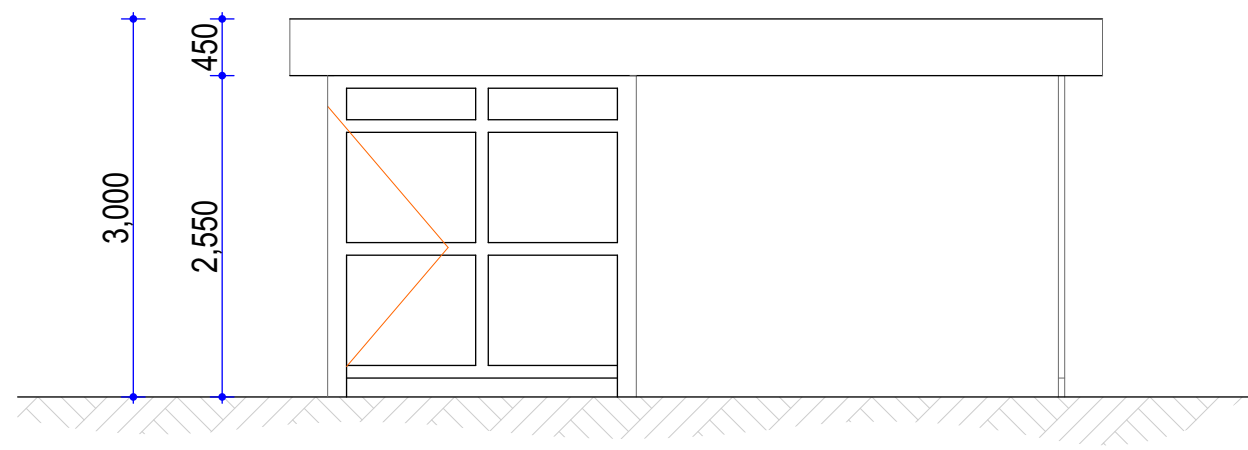

Elevation One

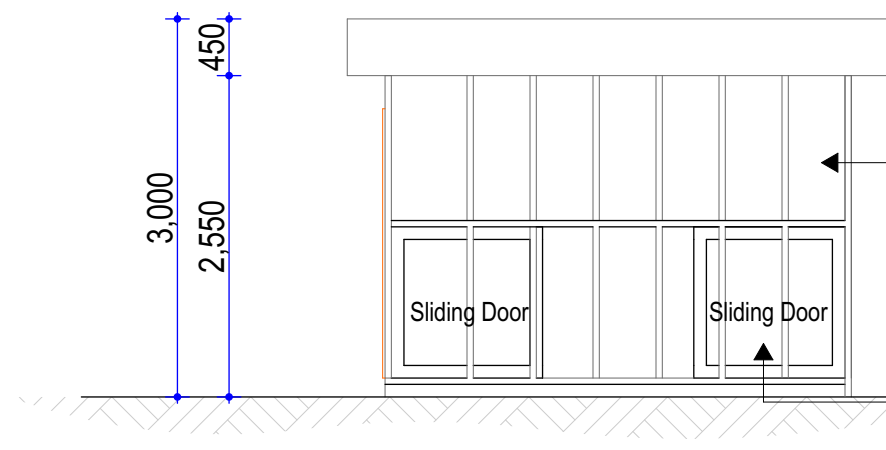

Elevation Two

8mm thick fixed glass
4mm thick steel plate welded on steel frames and spray painted to approval

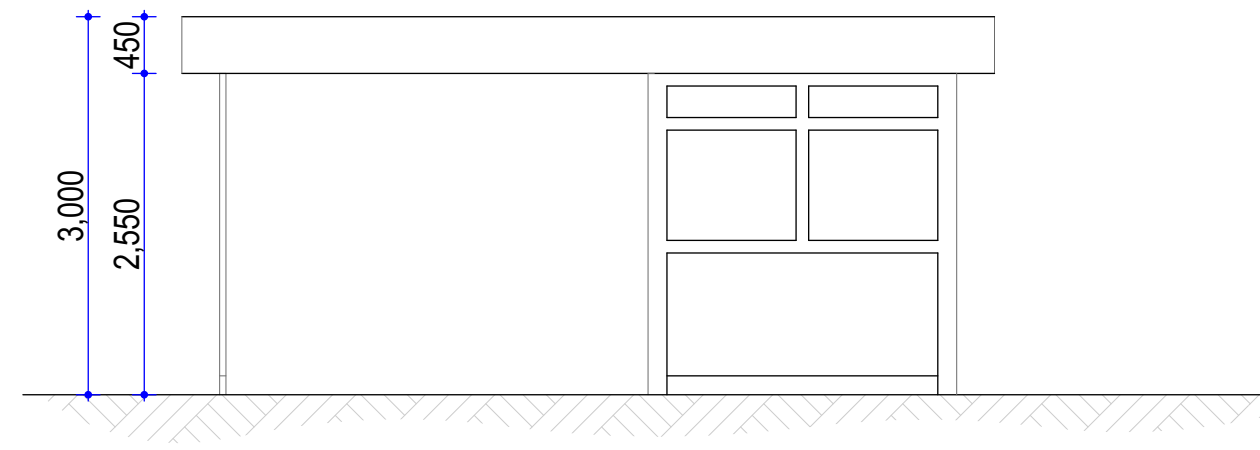

Elevation Three

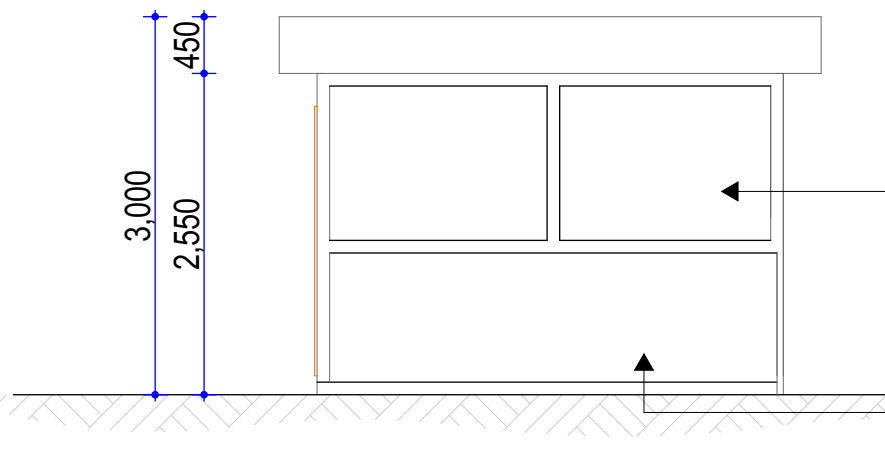

Elevation Four

8mm thick fixed glass
4mm thick steel plate welded on steel frames and spray painted to approval

project: Kesra Parking Lot	drawing description	Revision:	Scale: As Shown	
	Drawing No.	Date:	Date:	

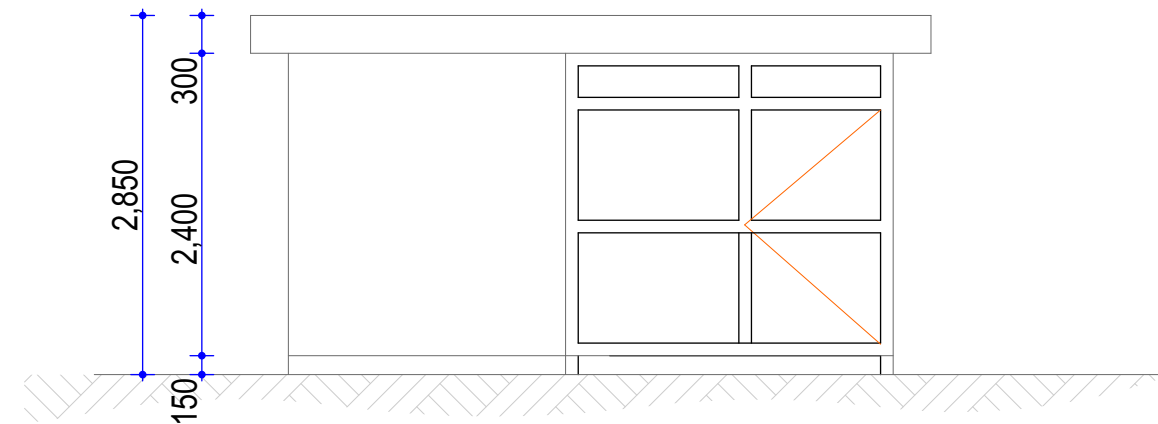
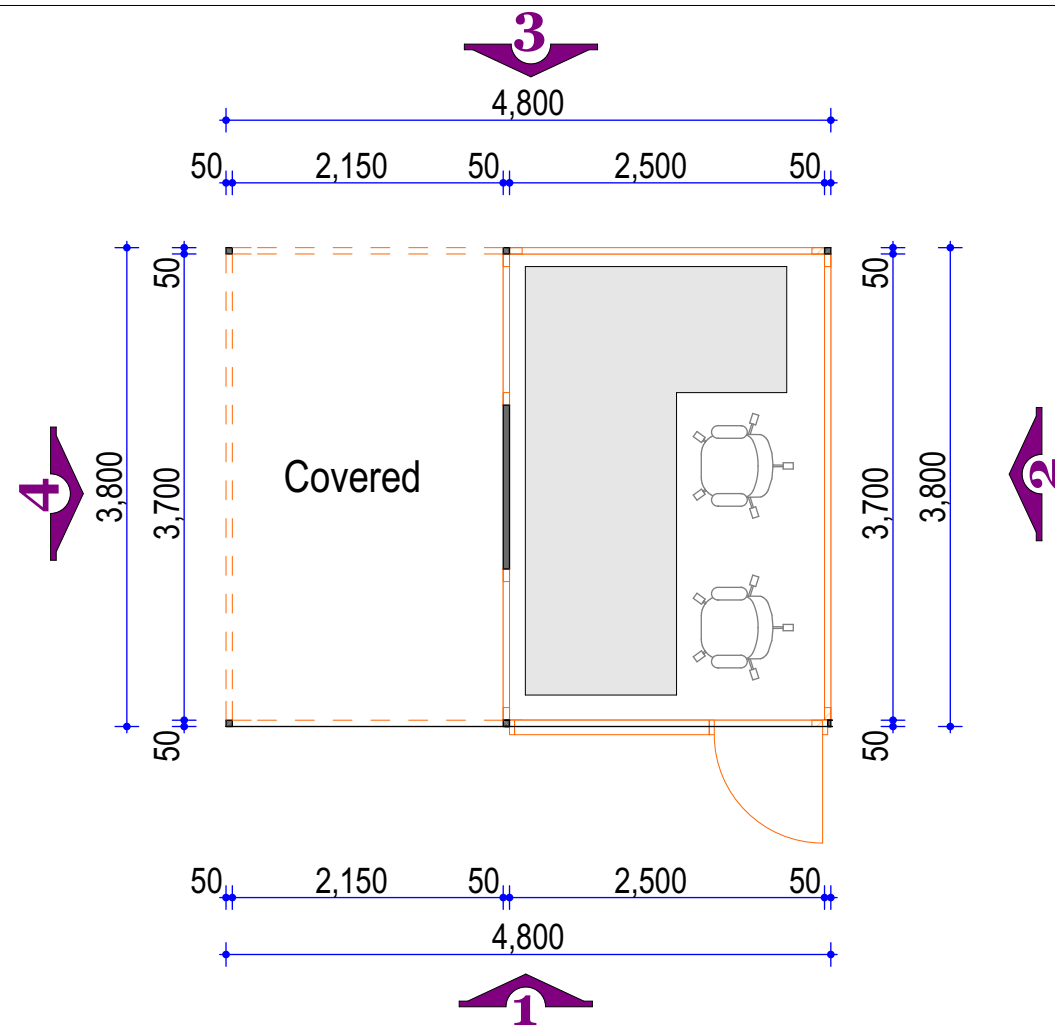

Elevation One

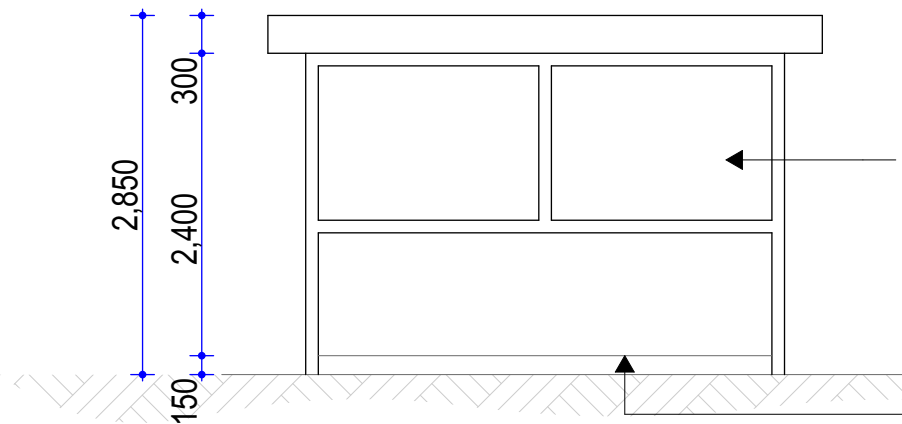

Elevation Two

8mm thick fixed glass
4mm thick steel plate welded on steel frames and spray painted to approval

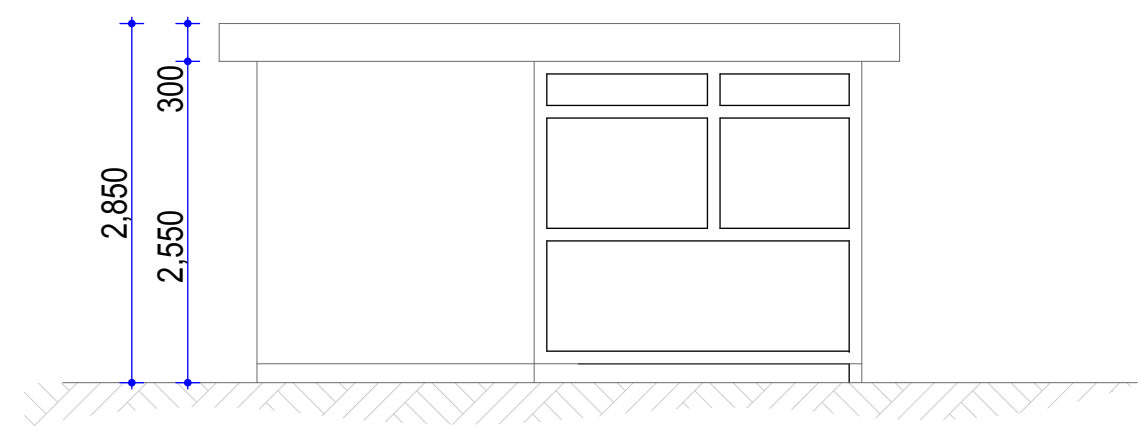

Elevation Three

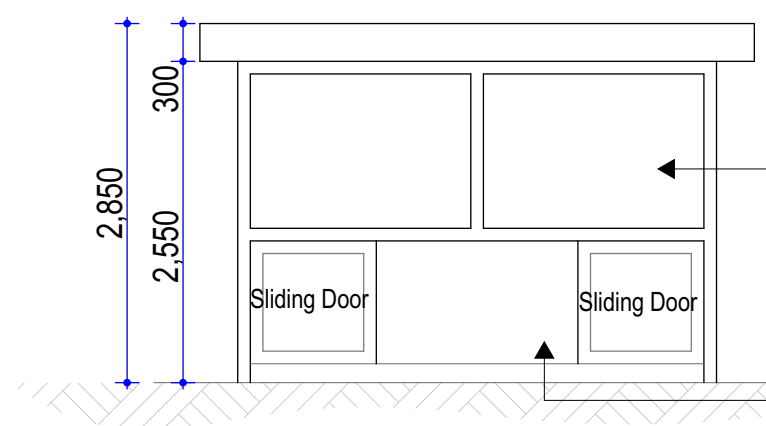

Elevation Four

8mm thick fixed glass
4mm thick steel plate welded on steel frames and spray painted to approval

project:	drawing description	Revision:	Scale: As Shown	
Forodha House		Date:		
	Drawing No.		Date:	

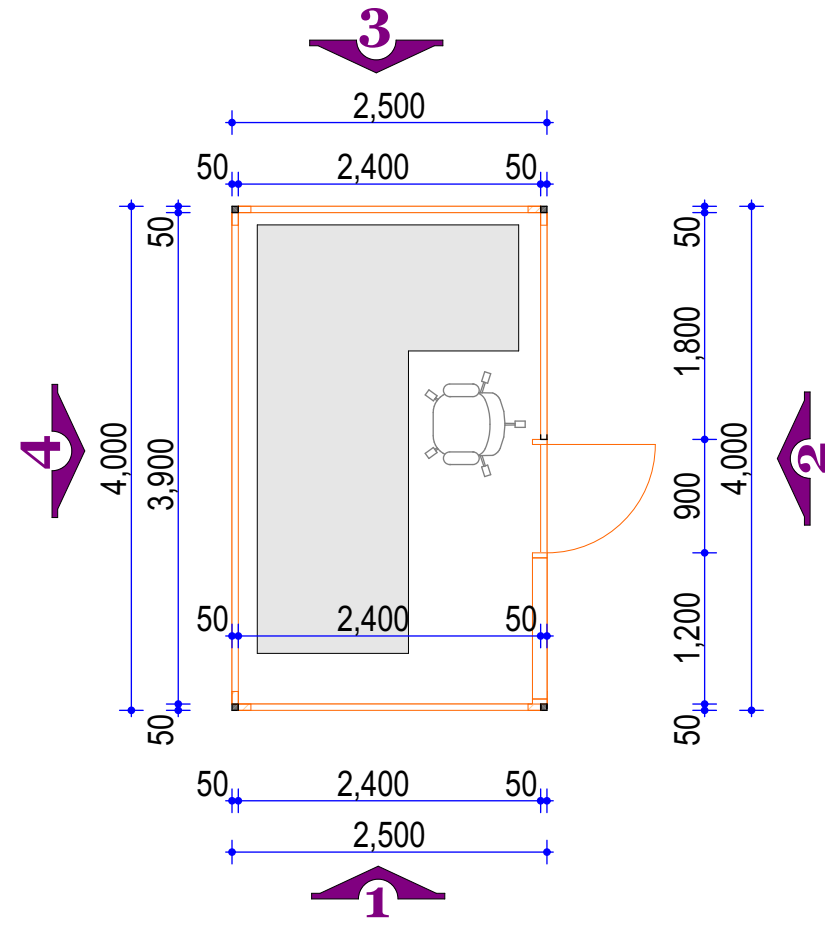

Malaba

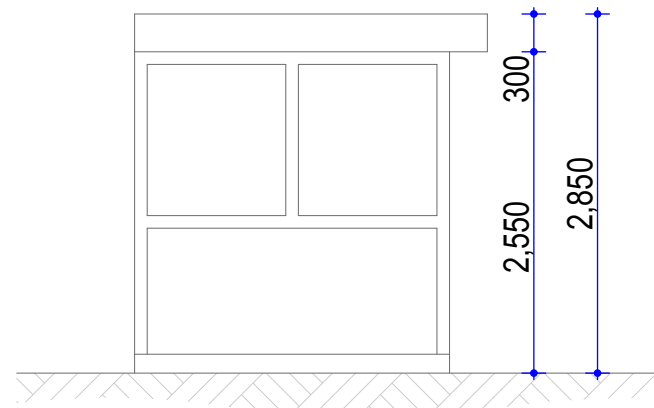

Elevation One

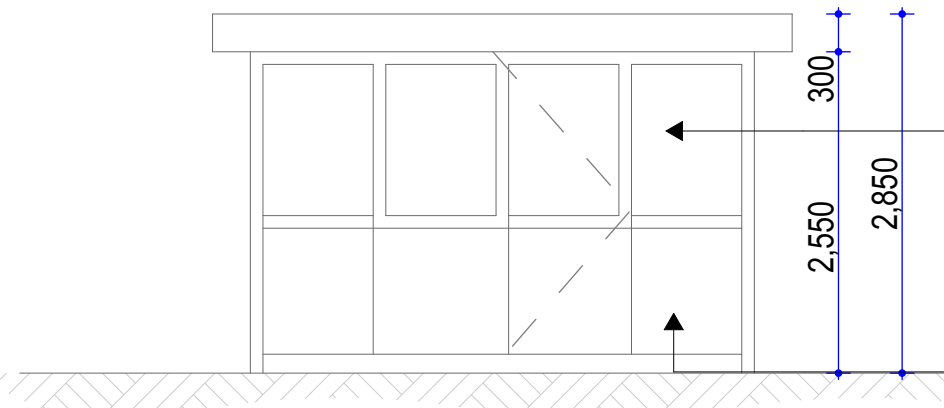

Elevation Two

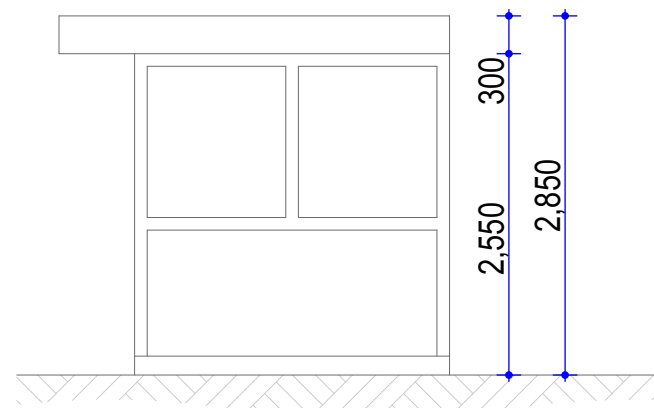

Elevation Three

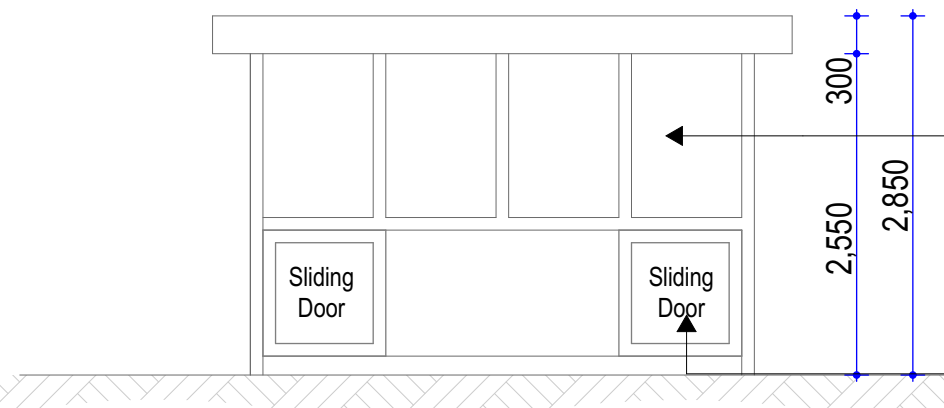

Elevation Four

project: Malaba	drawing description	Revision: Date:	Scale: As Shown	
	Drawing No.			

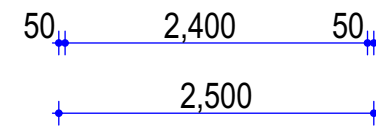
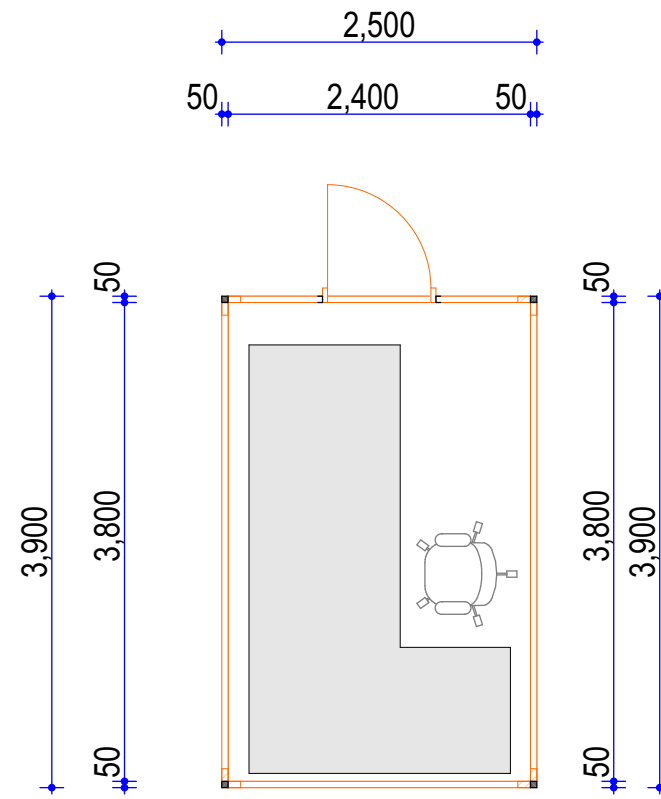

Naivasha

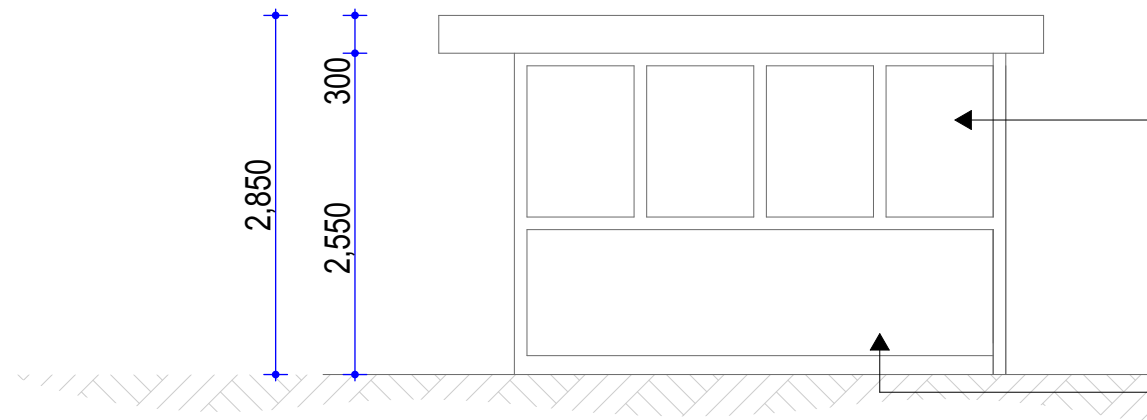
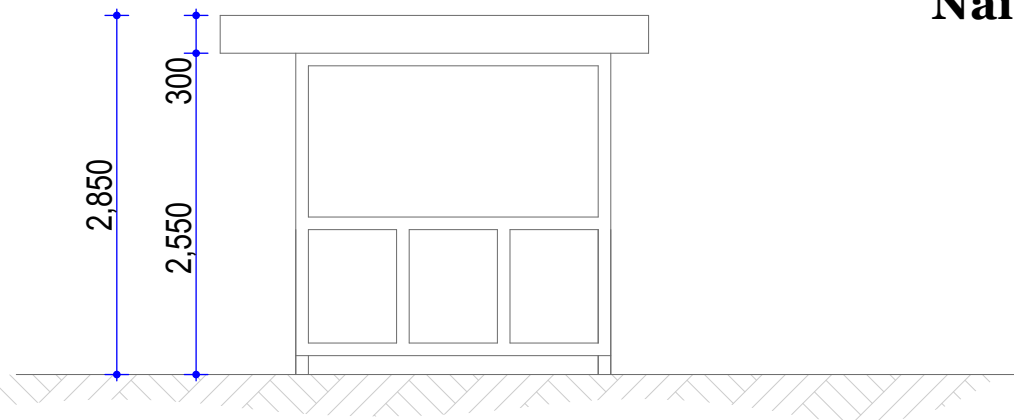

8mm thick fixed glass

4mm thick steel plate welded on steel frames and spray painted to approval

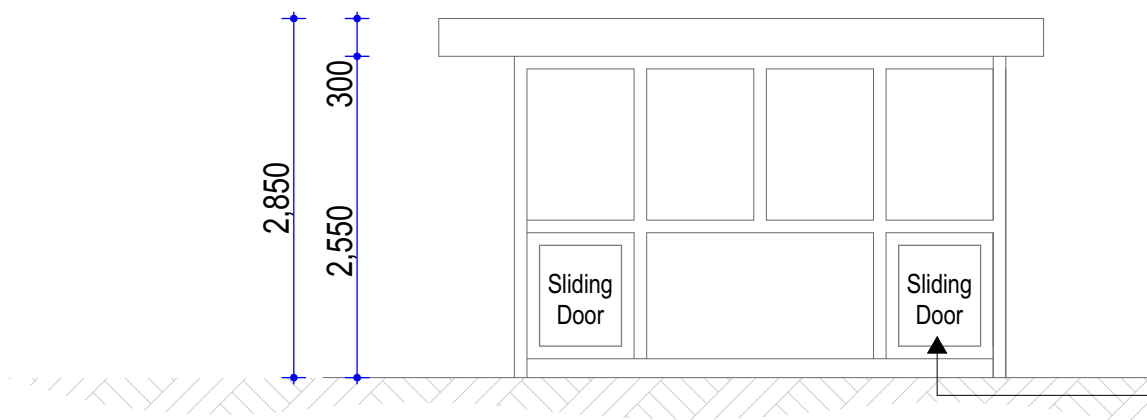
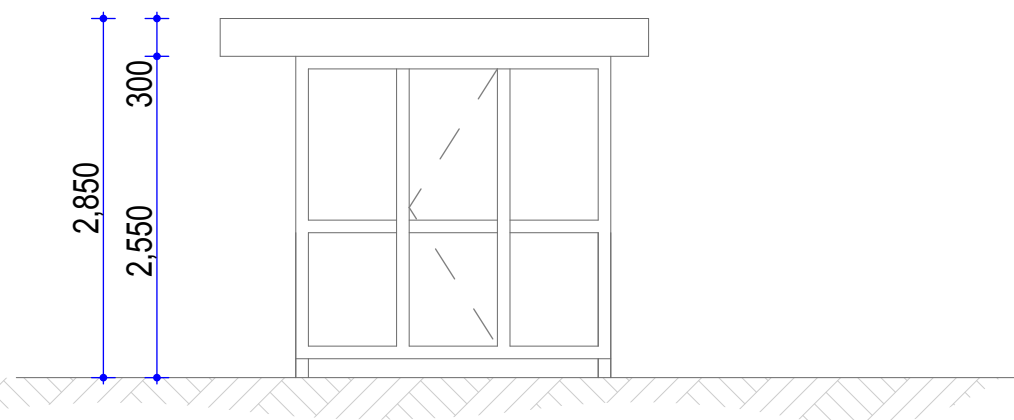

4mm thick steel plate welded on steel frames and spray painted to approval

project: Naivasha	drawing description	Revision:	Scale: As Shown	
	Drawing No.	Date:	Date:	

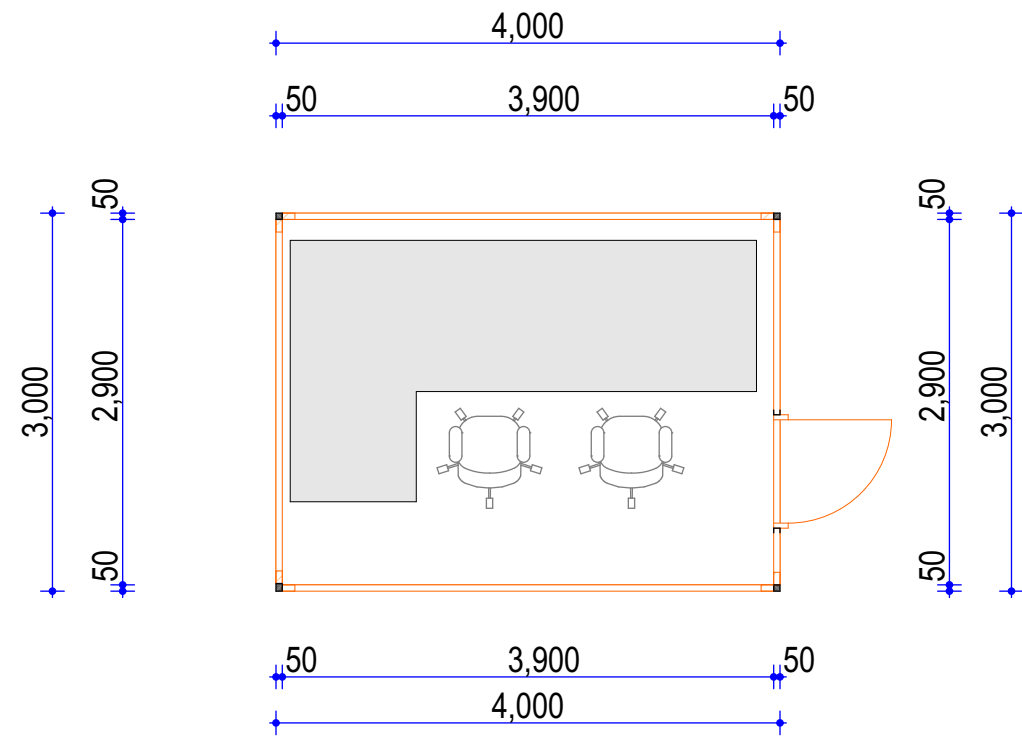

Nakuru

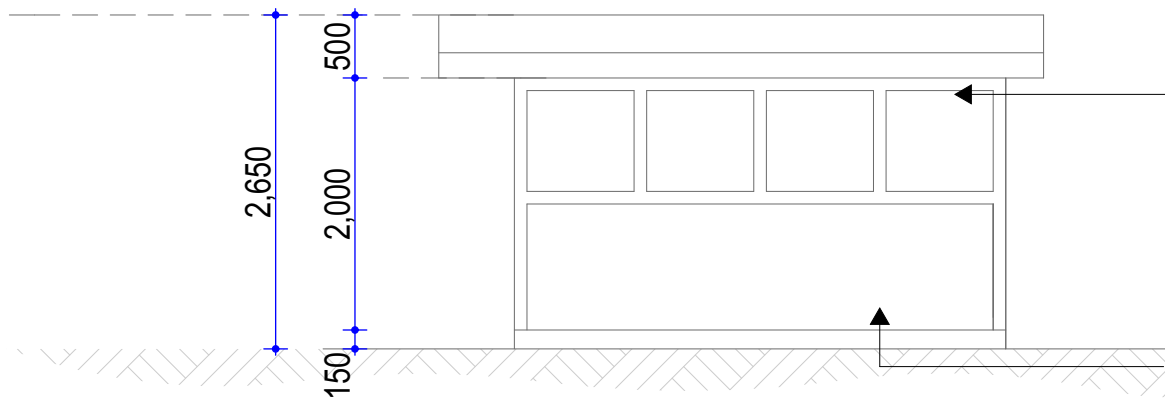
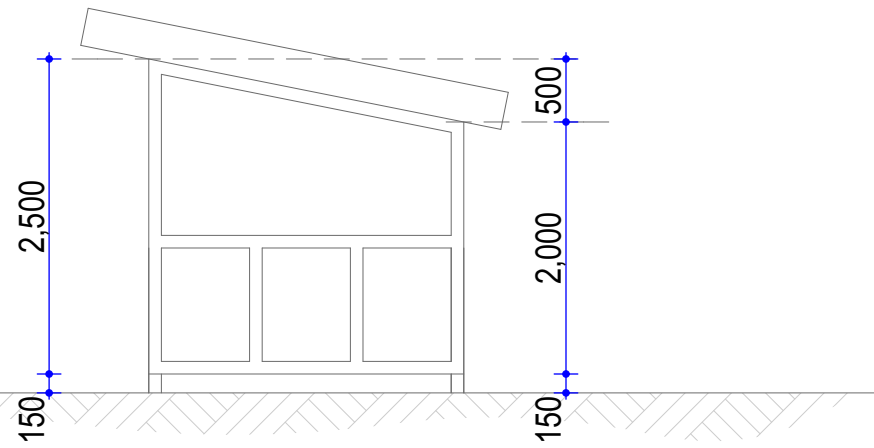

8mm thick fixed glass

4mm thick steel plate welded on steel frames and spray painted to approval

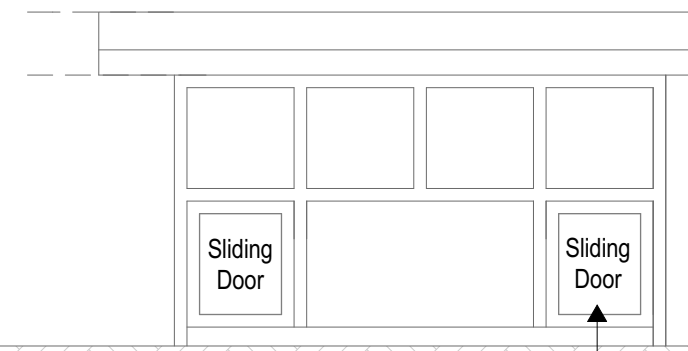
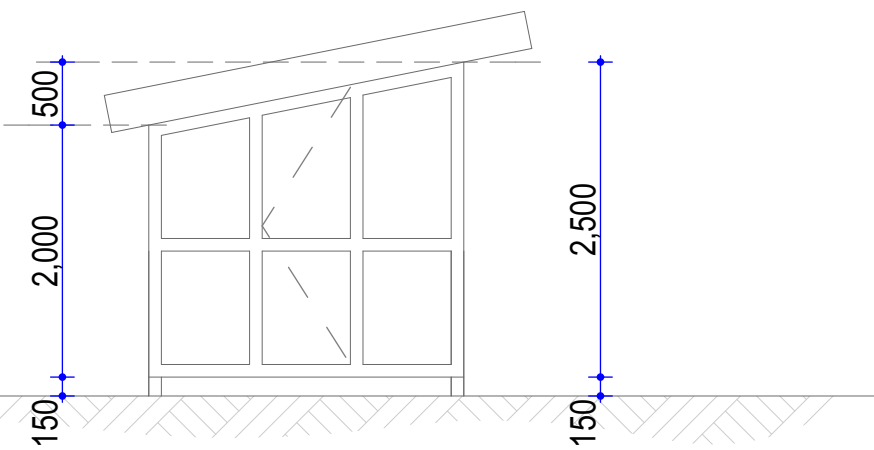

4mm thick steel plate welded on steel frames and spray painted to approval

project: Nakuru	drawing description	Revision: Date:	Scale: As Shown	
	Drawing No.		Date:	

Custom House Mombasa Entrance

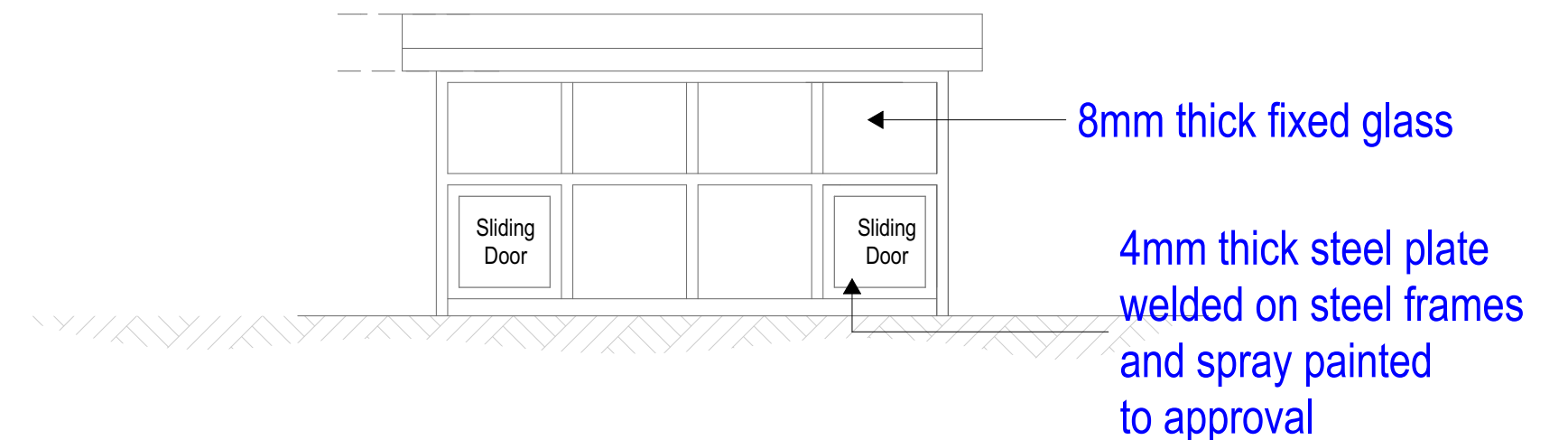
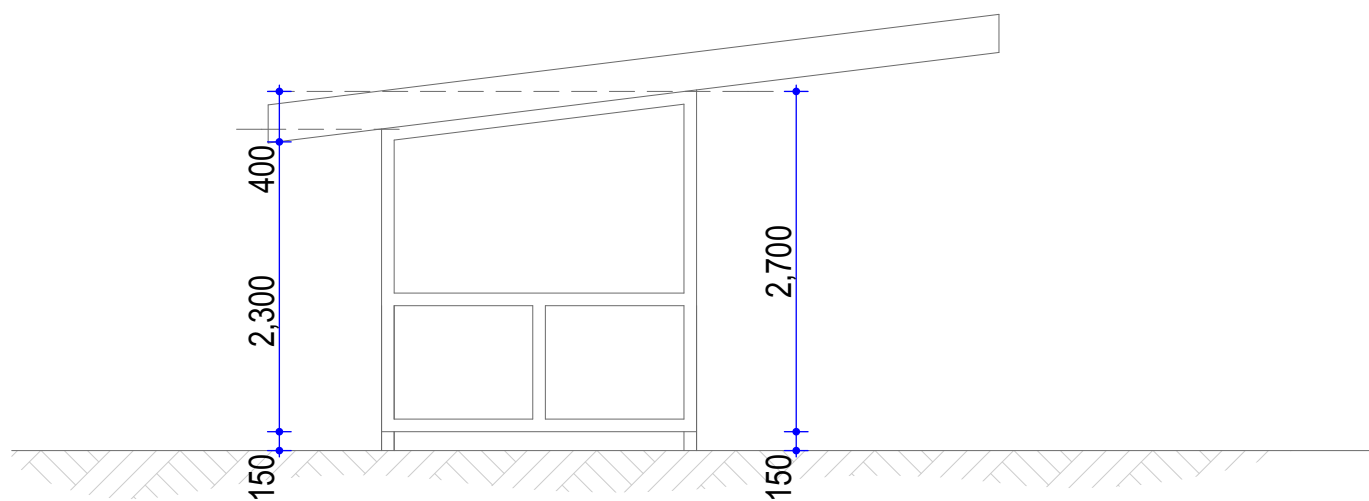
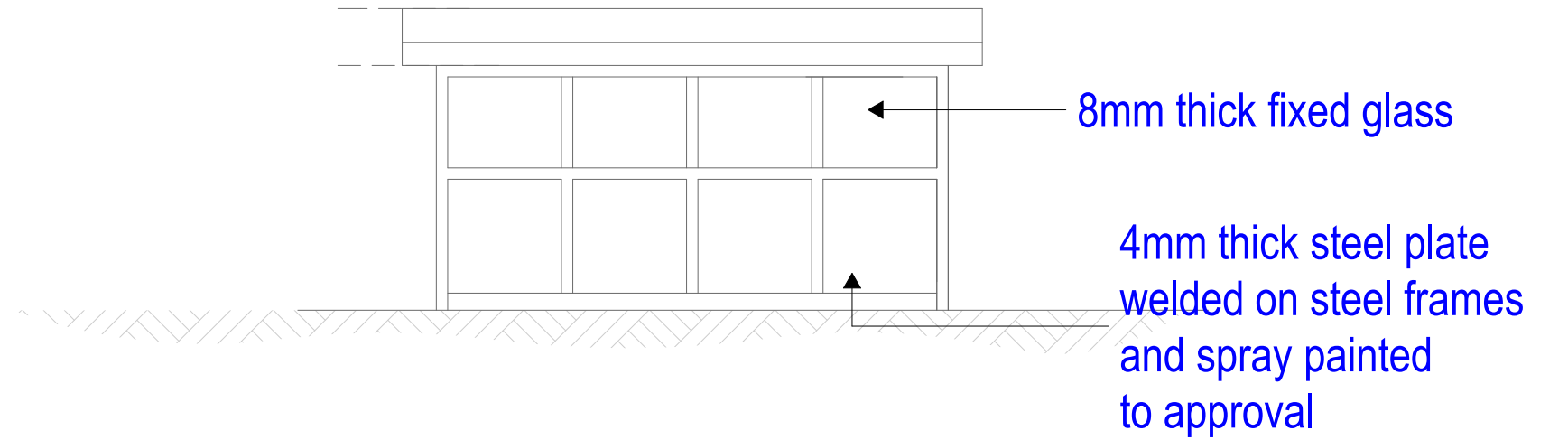
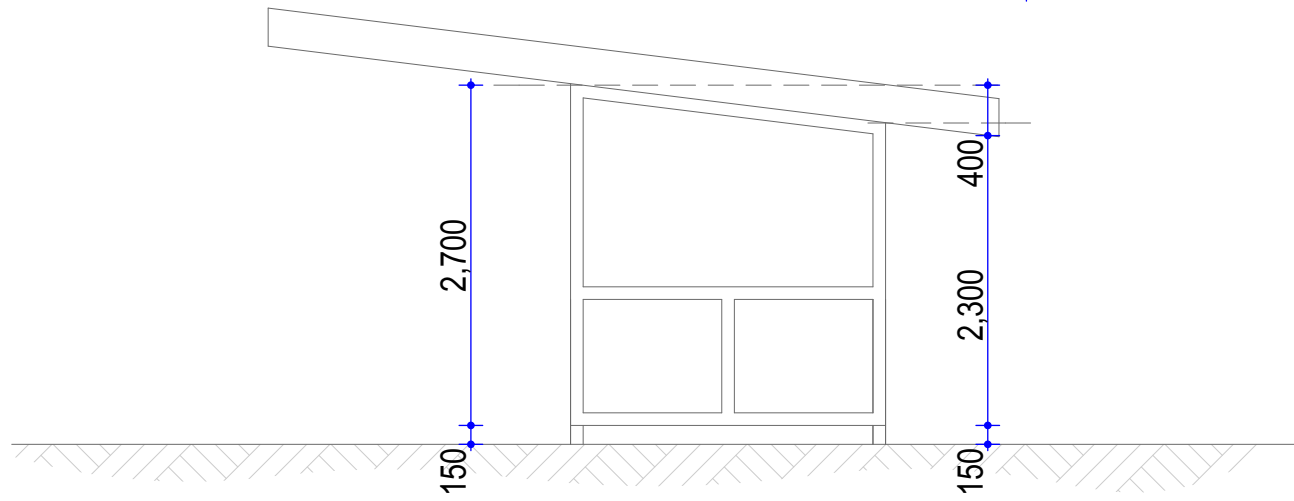
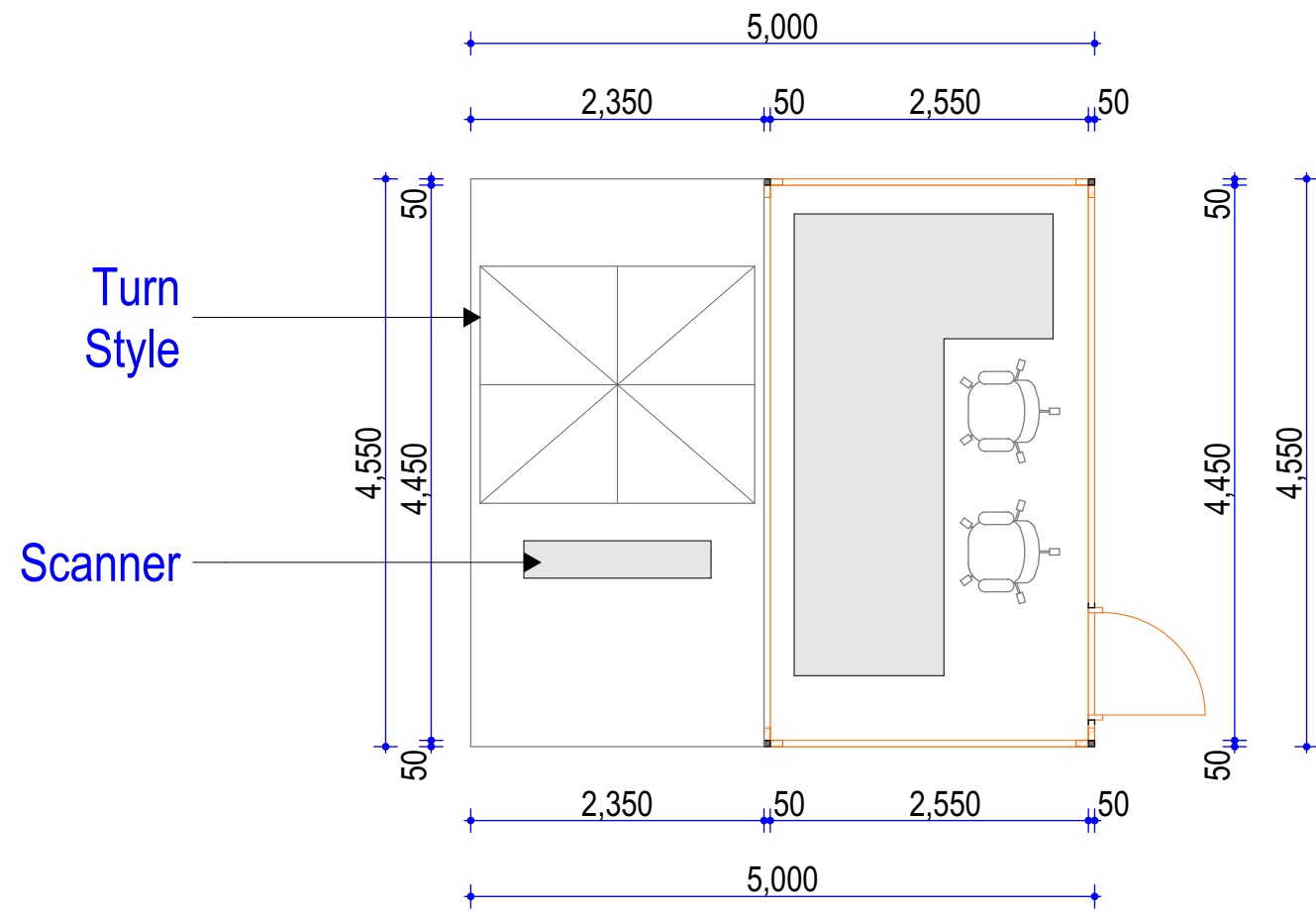

project: Custom House Mombasa Entrance	drawing description	Revision:	Scale: As Shown	
	Drawing No.	Date:	Date:	

Custom House Mombasa Exit

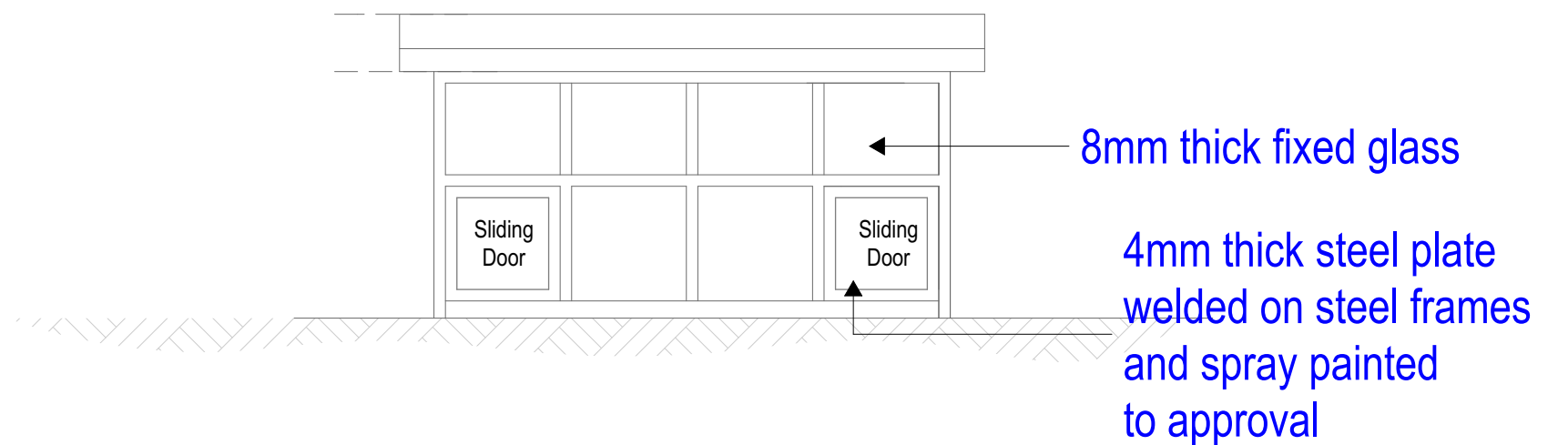
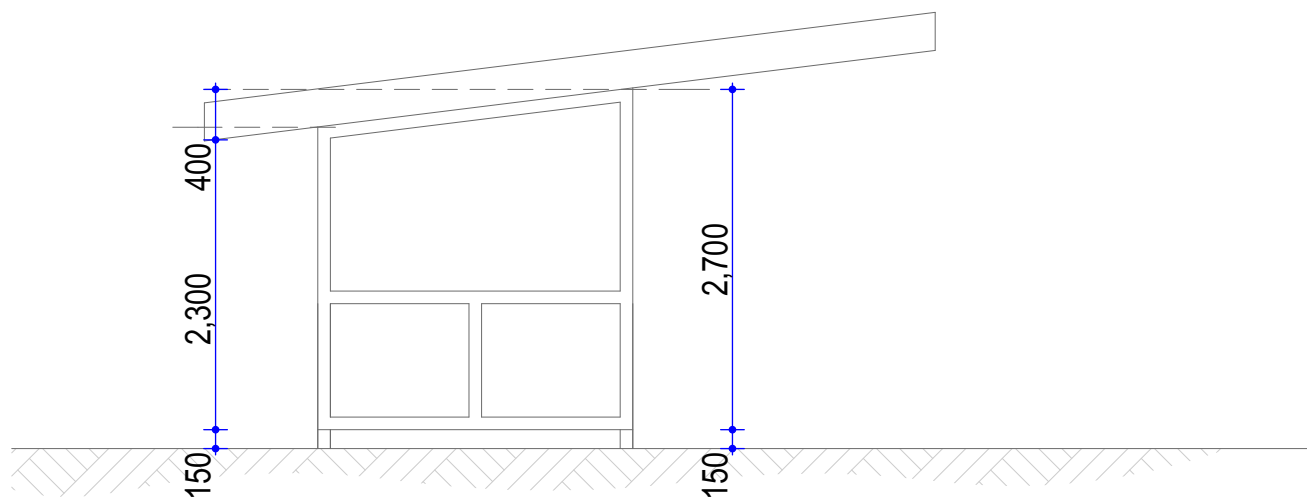
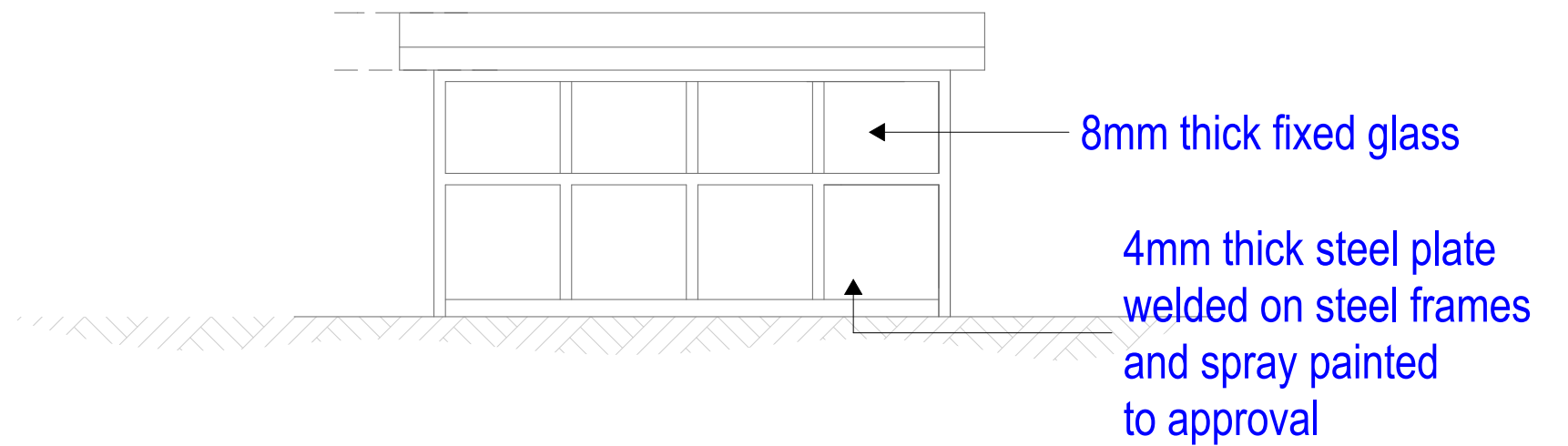
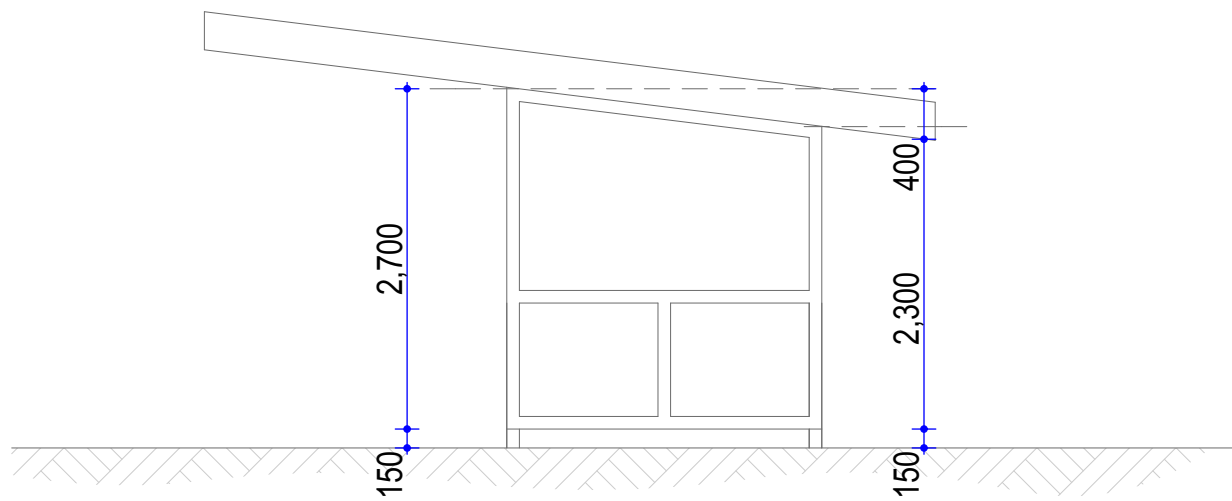
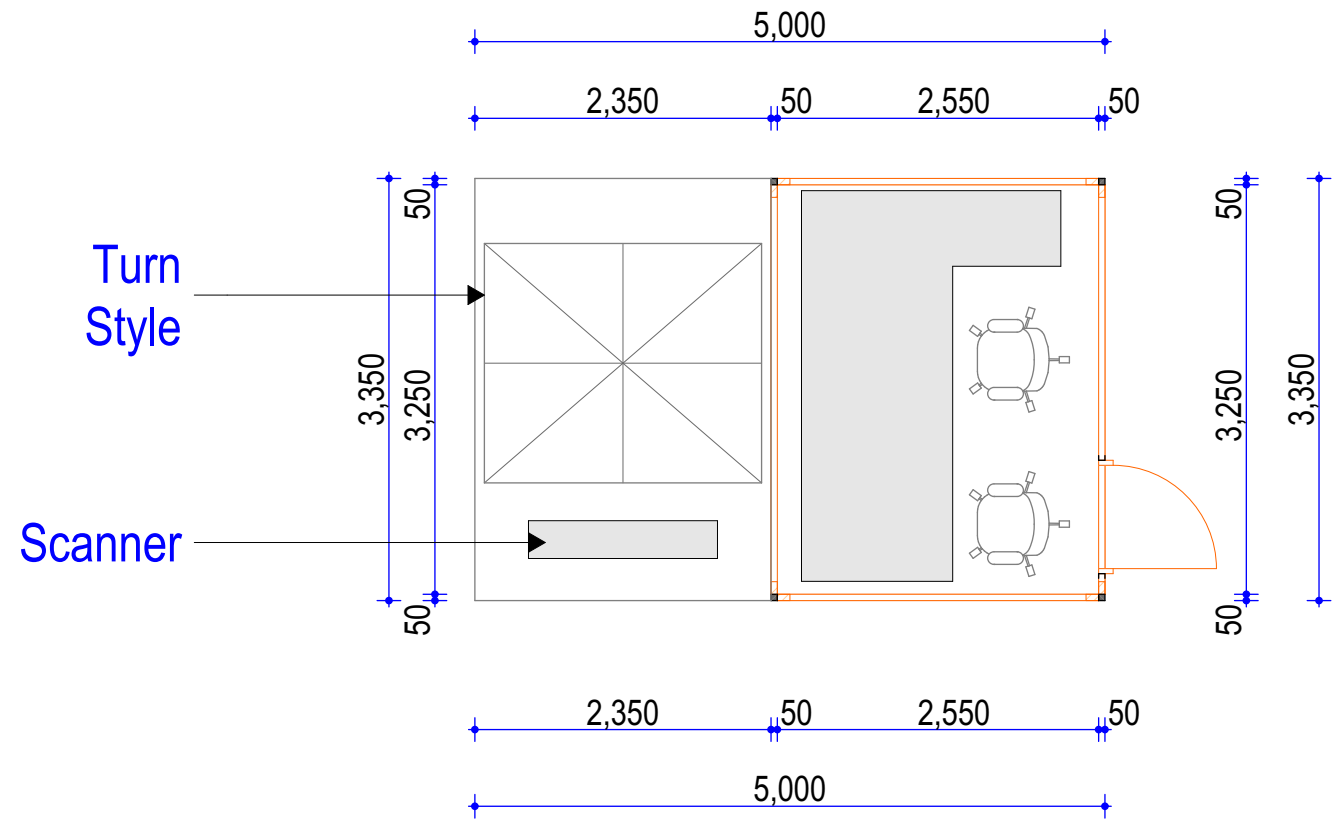

project: Custom House Mombasa Exit	drawing description	Revision: Date:	Scale: As Shown	
	Drawing No.			

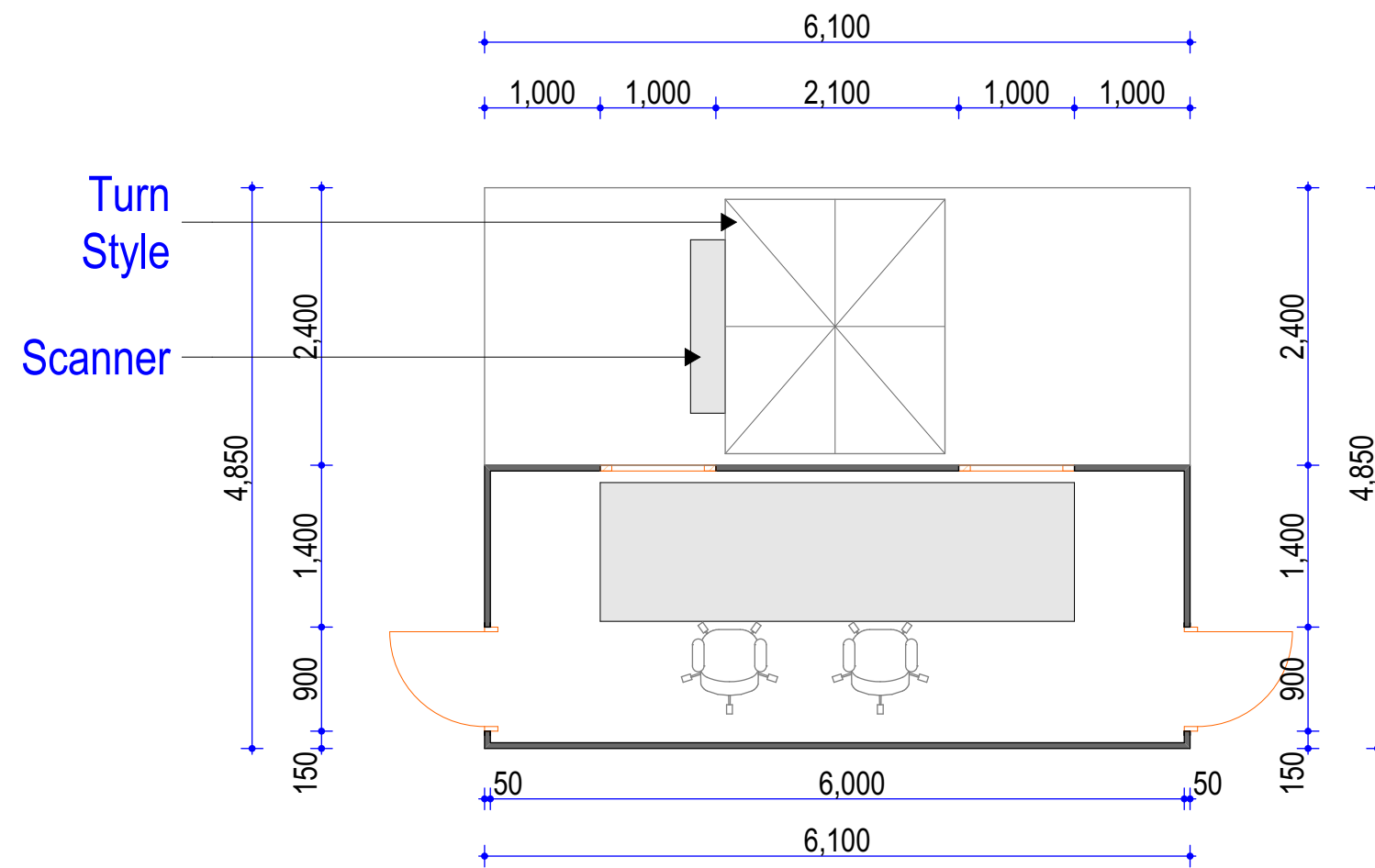

KESRA Mombasa Exit - Container
KESRA Mombasa Entrance - Container

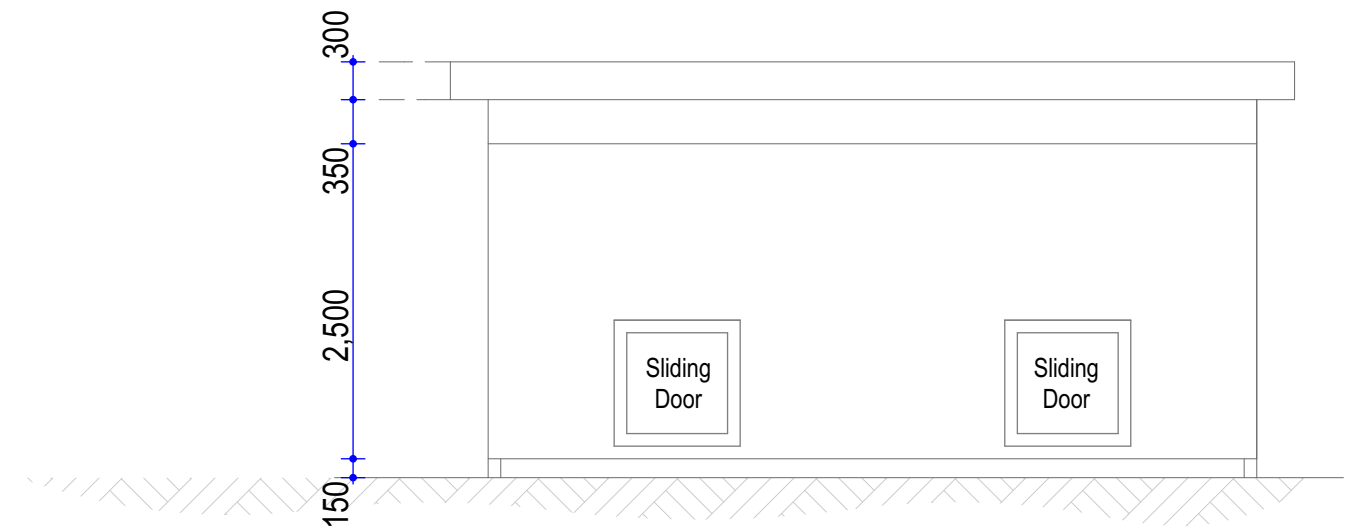
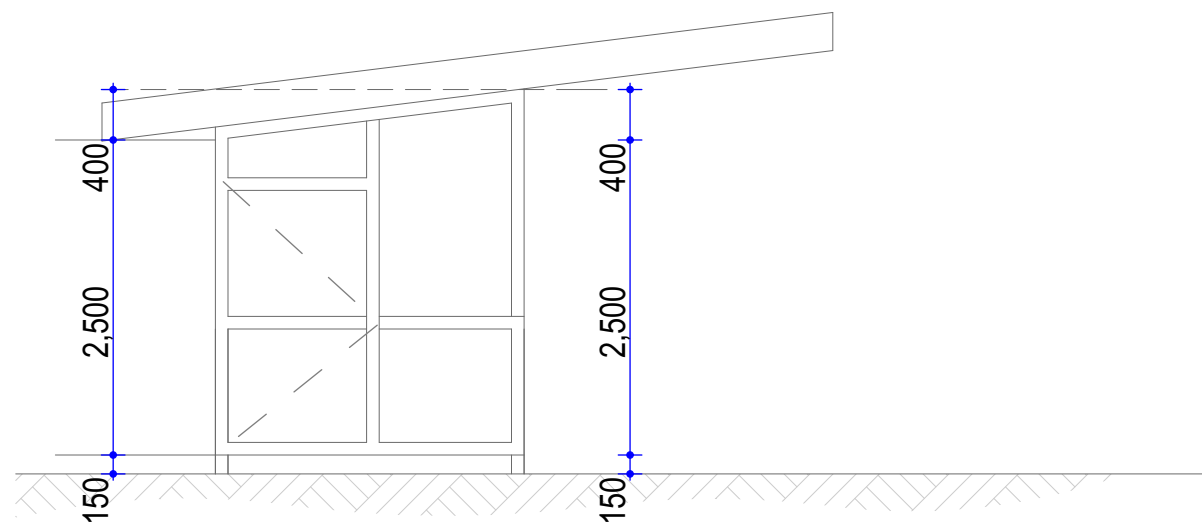
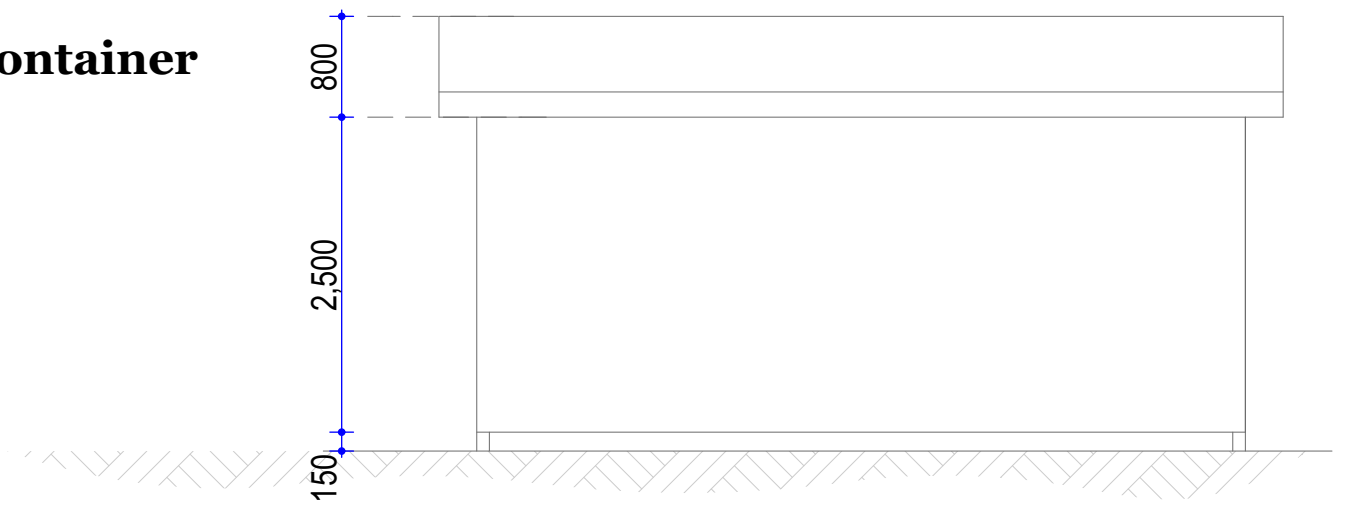
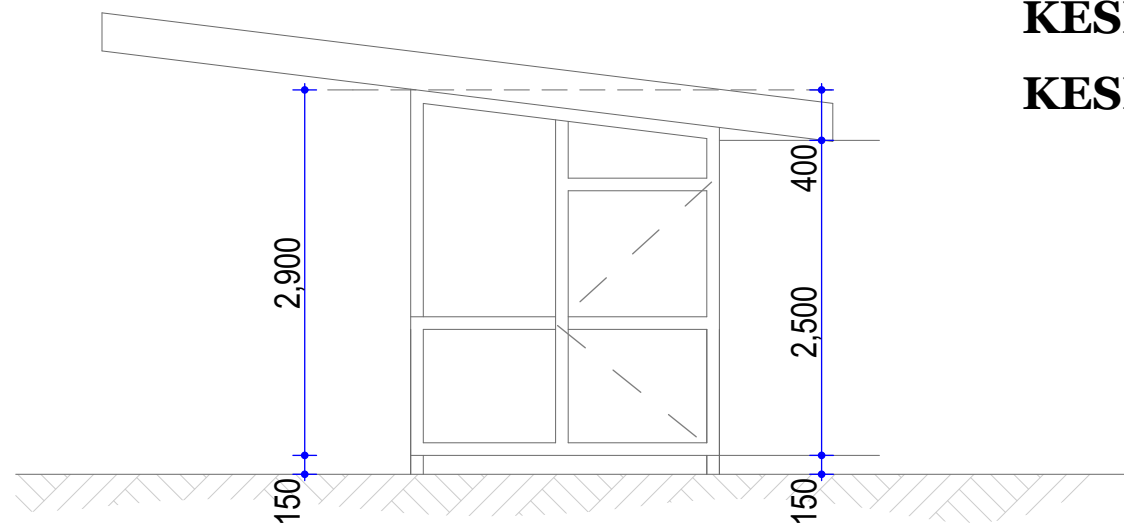

project: Kesra Mombasa	drawing description	Revision: Date:	Scale: As Shown	
	Drawing No.			

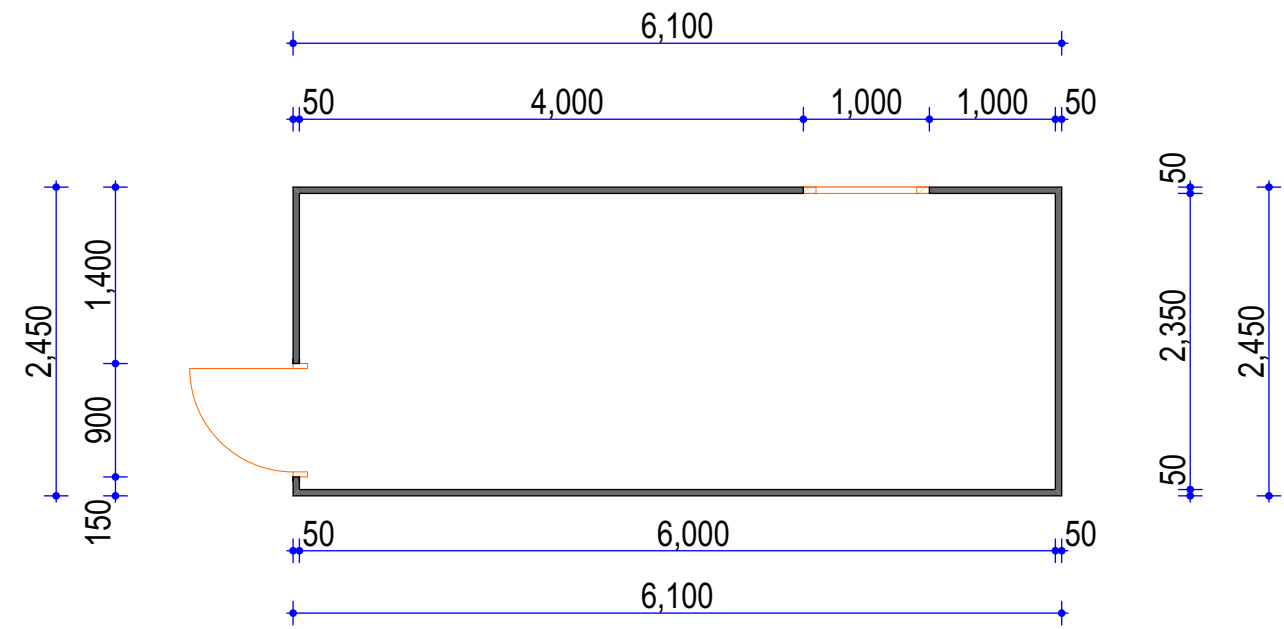

**Custom House Mombasa (Staff)
Container**

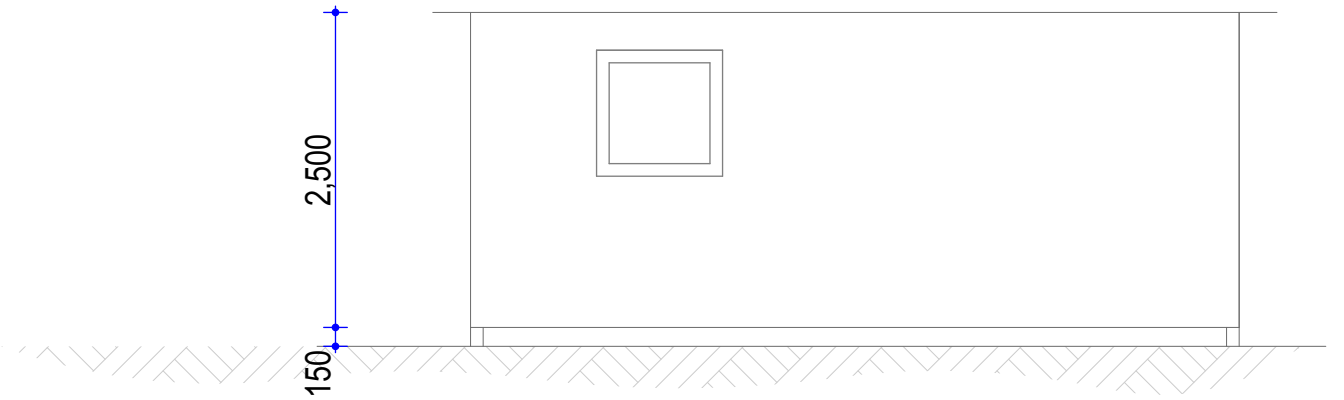
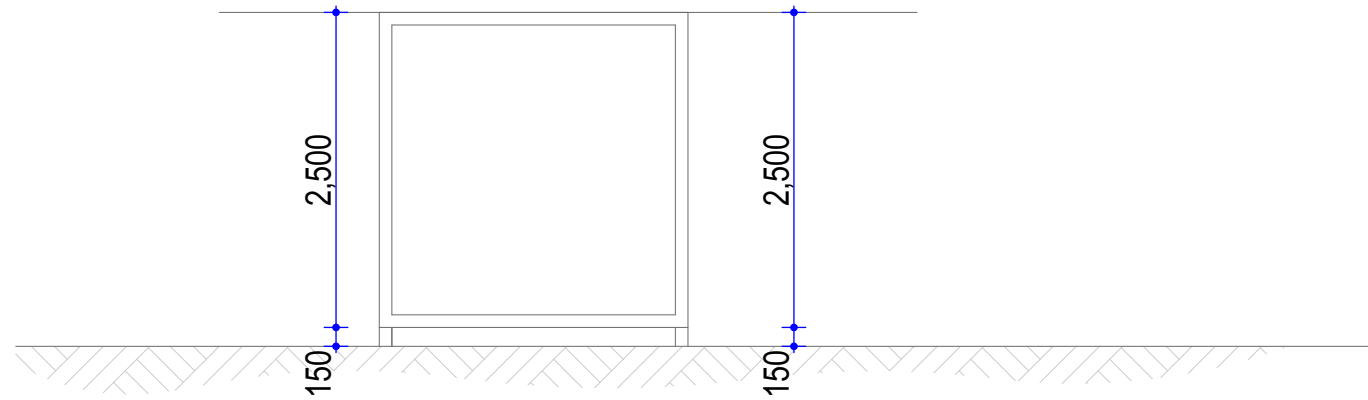
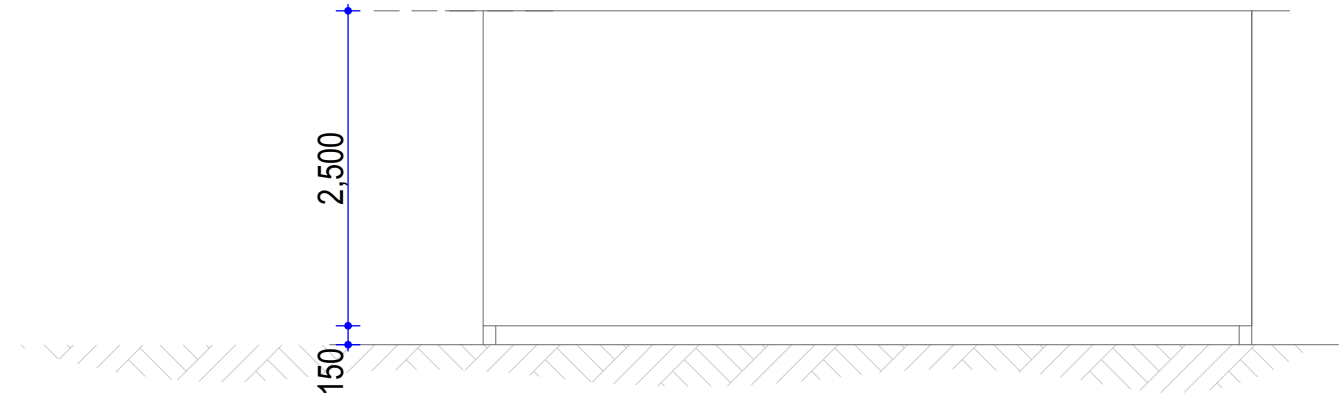
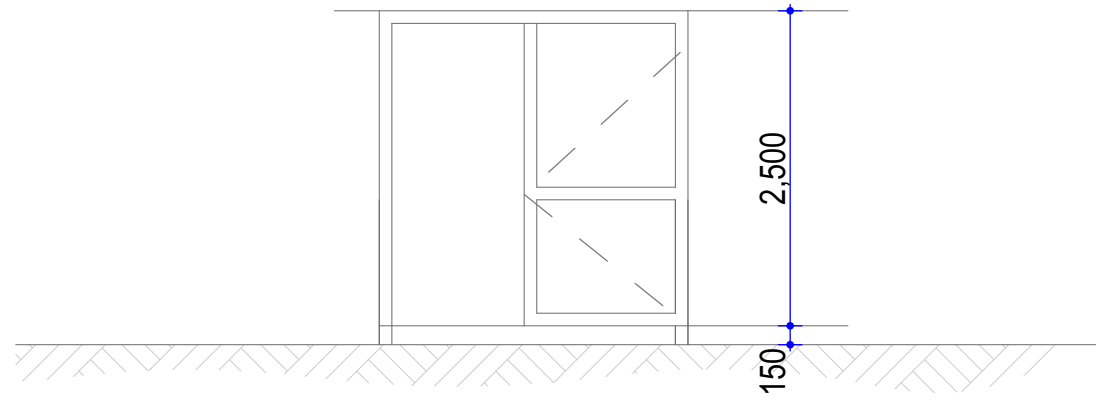

project: Custom House Mombasa (Staff)	drawing description		Revision:		Scale: As Shown	
	Drawing No.		Date:			
			Date:			